

## E-210 USER'S GUIDE

### 1. DEFINITION



E-210 Series Universal Profile Controllers are designed to use On/Off and PID Control Techniques, by using new generation microcontrollers. The dimensions of the controllers are 96x96 mm confirming IEC/TR 60668 standard. The controllers have two 4-digit seven segment led displays each capable of displaying numeric values from -1999 to 9999 and 4-character alphanumeric values messages. The universal inputs (T/C, R/T, mV, mA) are configurable are measured with 16-bit resolution.

These electronic units, have high reading accuracy with high measurement sensitivity, don't contain any loose mechanical parts, and provide limitless reliability. They are calibrated in order not to be defected by time and exterior factors. High input

impedance, protection of the system from loss of signal, E-210 has two separate, 4-digit, display to display process value and set values within the range of -1999 to 9999. For all industrial applications for the measurement and control of; temperature pressure, level speed current-voltage, resistance and other physical features, also for areas such as; Iron-Steel, Cement Chemistry, Food, Plastic, Petrochemistry, Refineries, Ceramics, Glass and industries this unit is ideal.

### 2. TECHNICAL FEATURES

<b>Input Types</b>	<b>Thermocouple ( TC ) :</b> B, E, J, K, L, N, R, S, T, U (Temperature Sensor) <b>Resistance Thermometre ( RT ):</b> Pt100 (Temperature Sensor) <b>Current:</b> 0-20 mA, 4-20 mA (Linear) <b>Voltage:</b> 0-50 mV, 0-1 V, 0.2-1 V (Linear)
<b>Control Outputs</b>	<b>Relay:</b> SPST-NO 250V AC, 5A <b>Current:</b> 0-20 mA, 4-20 mA (Isolated) <b>Pulse:</b> 24V DC, 25 mA (for SSR)
<b>Alarm Outputs</b>	<b>Relay:</b> SPST-NO 250V AC, 5A
<b>Display Type</b>	2 x 4 digits 14mm 7 segment led display
<b>Accuracy</b>	<b>Thermocouple:</b> ( %0.5 or 1 °C of the displayed value) 1 digits max. <b>Pt-100:</b> ( %0.5 or 1 °C of the displayed value) 1 digits max. <b>Voltage/Current:</b> %0.5 FS 1 digit max.
<b>A/D Converter</b>	16 bits
<b>D/A Converter</b>	12 bits
<b>Control Form</b>	On/Off, PID
<b>Operating Voltage</b>	85-265 V AC / 85-375 V DC 20-60 V AC / 20-85 V DC
<b>Power Consumption</b>	7W (10 VA)
<b>Operating Temperature</b>	-10 °C, +55 °C (14 °F, +131 °F) (Without Condensation and Evaporation)
<b>Storage Temperature</b>	-25 °C, +65 °C (-13 °F, +149 °F) (Without Condensation and Evaporation)
<b>Relay Mechanical Life</b>	10.000.000 On-Off
<b>Relay Electrical Life</b>	>1.000.000 On-Off (1/10 of the load)
<b>Memory</b>	EEPROM (100.000 max. Write- erase)
<b>Weight</b>	430 g

**3. ORDERING GUIDE**

E-210-W-X-Y-Z

W	Relay/SSR	X	Analog Output	Y	Communication	Z	Power Supply
2	2 Relay	0	No Analog Output	0	None	0	85-265 V AC / 85-375 V DC
3	3 Relay	1	1 Analog Output	1	RS 485	1	20-60 V AC / 20-85 V DC
4	4 Relay	2	2 Analog Output				
5	1 Relay, 1 Pulse for SSR						
6	2 Relay, 1 Pulse for SSR						
7	3 Relay, 1 Pulse for SSR						

**4. DIMENSION**

The outer dimension of E-210 are shown below in **Figure 4.1**:

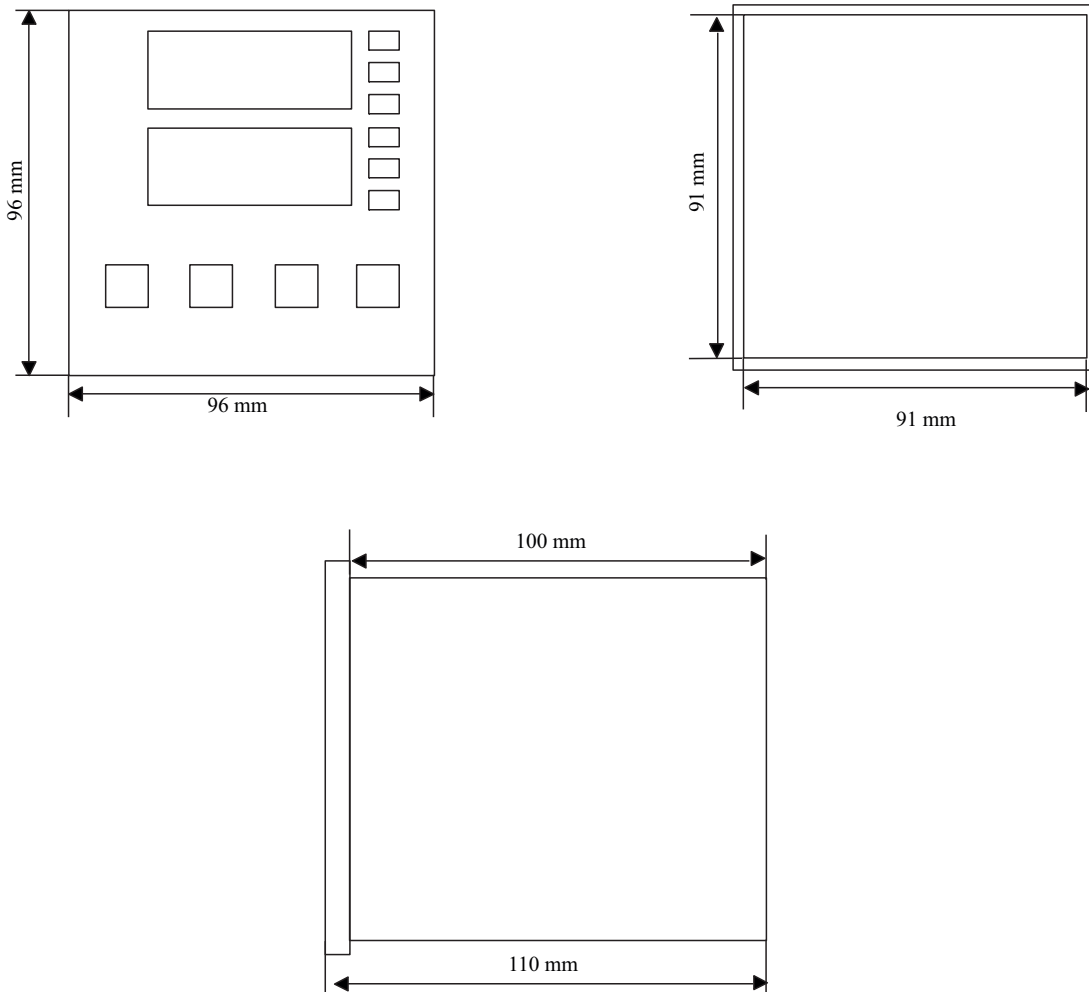

**Figure 4.1**

## 5. PANEL MOUNTING

Carefully locate the unit into its suitable space. Screw the clips into their suitable spaces located under and at the top of the unit. If more than one units are to be attached to the same panel, there should be at least 100mm space between the locations of the units side by side as shown below. In the case of closely attached units, the increase in the temperature due to the units, should be considered carefully.

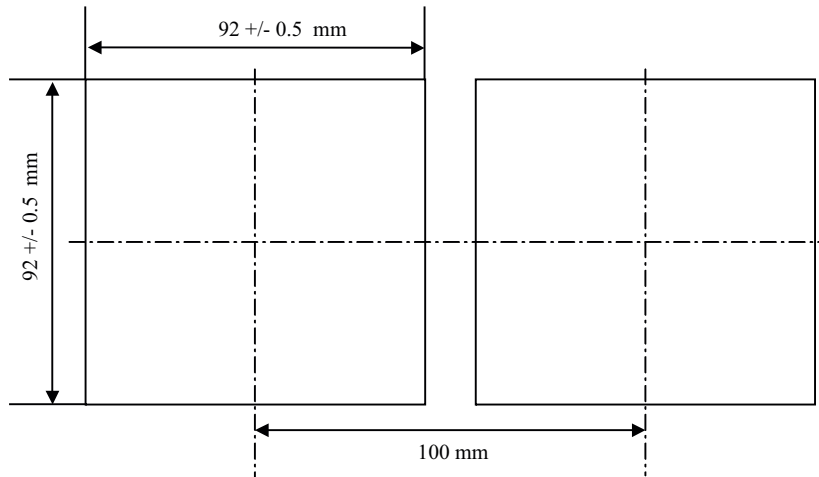

**Figure 5.1**

## 6. WARNINGS

- ☞ Do not touch the terminals when the unit is energized.
- ☞ Make sure that the unit is powered by the power source of instruments (i.e from an isolated 220 VAC transformers)
- ☞ Make sure to connect the High-Current and High-Voltage lines separately from other lines.
- ☞ Keep the unit away from flammable gases, that could cause explosions.
- ☞ Any metal, entering the unit can cause unit to malfunction or electrical shocks. Make sure no metal piece gets in the unit.
- ☞ The relay life differs according to the usage configuration. When the relays are old, their contacts could melt or burn out.
- ☞ The configurations should be made according to the desired control type. Otherwise, malfunctioning units can cause accidents.
- ☞ Precautions should be taken in case of malfunctioning units. For example have an external alarm system for the temperature or pressure changes.
- ☞ Use the unit only in the specified area.
- ☞ The product life of this instrument is 10 years.

## 7.FRONT PANEL

The front panel of E-210 is as shown in **Figure 7.1**.

**R1 Led:** On when relay 1 is active.

**R2 Led:** On when relay 2 is active.

**R3 Led:** On when relay 3 is active.

**R4 Led:** On when relay 4 is active.

**PR Led:** On when the unit is at programming mode.

**MN Led:** On when the unit is in manual mode. Also during autotuning, this led is blinking,, stating the autotuning is in process .

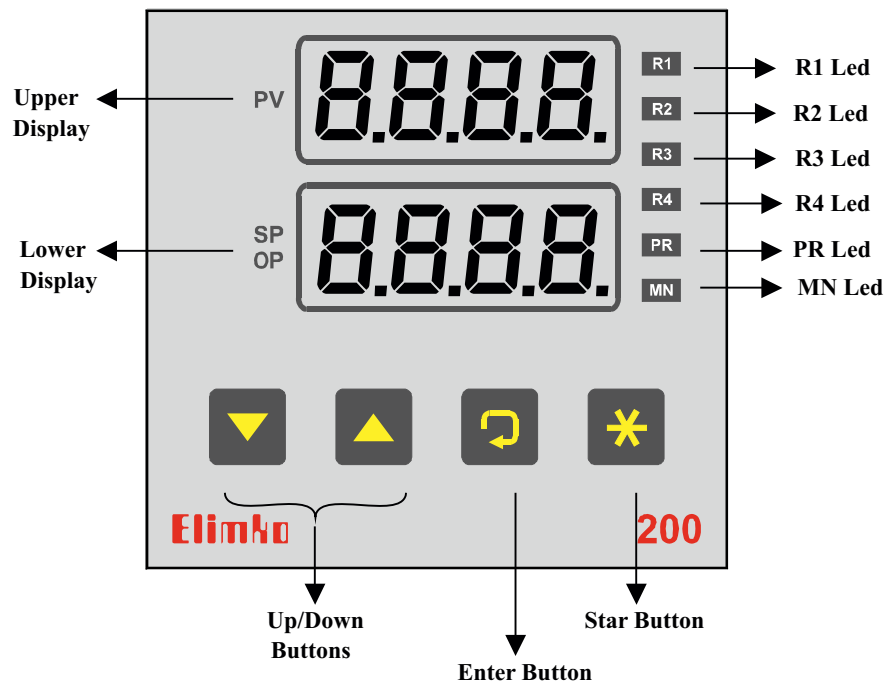

**Figure7.1**

**Upper Display:** A 4 digit display shows, the instantaneous value and the errors during the process, parameters` names, in programming mode. Also passing through the menus, both displays are used.

**Lower Display:** A 4 digital display shows, the set value in automatic mode, the output percentage in manual mode and the parameter values in programming mode.

⊛ **Star Button**, used to exit the menus. When pressed together with ↻ programming starts. When the units is in PID mode, and not programming, pressing this button for every 3 seconds, changes from automatic and manuel modes. Also, not programming, pressing this button once resets the alarms.

↻ **Enter Button**, used to reach the menus. Also pressed with ⊛ programming starts.

▼ **Down and ▲ Up Buttons** change the output and the parameter values. Also used to change between the displays. Pressed with ⊛ , to save the calibration, to start and stop the program.

**8.CONNECTION DIAGRAMS**

The connection schemes for E-210 are as shown in **Figure 8.1** .

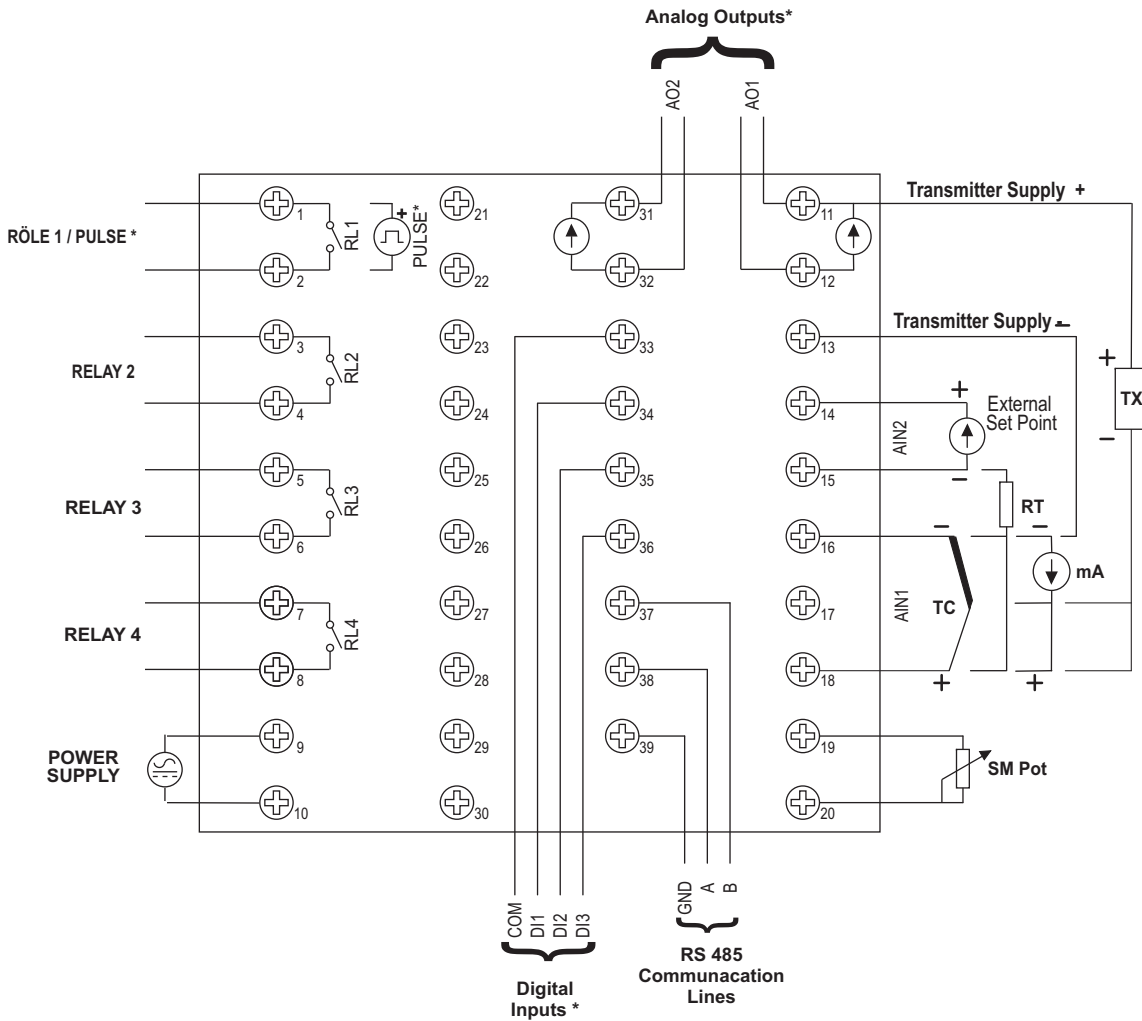

**Figure 8.1**

**\*Digital Input Connection**

DI1: Automatic/Manuel mode selection

SP5r=when d inP ; SEt 1, SEt2, SEt3 and SEt4 in the D12 and D13 SEtP display. (Table 22)

SP5r=when PrFL ; DI2: Start and Stop operating D13:Hold and continue the operation.

\*AO1,AO2 Analog Outputs, **Pulse outputs** and **Digital Inputs** are not isolated.

**9.ERROR MESSAGES**

Message	Meaning	What To Do
<b>oPEn</b>	The connection of the sensor is broken.	Check the sensor and the sensor connections.
<b>uFL</b>	The process value is below the sensor type-temperature interval.	Check the sensor and the input type specified by the <b>inP t</b> parameter.
<b>oFL</b>	The process value is above the sensor type- temperature interval.	
<b>nnnn</b>	The process value is above the value that can be displayed.	Check the analog value on the input connection and the scalar specified by the <b>dP</b> , <b>ZEro</b> and <b>SPAn</b> parameters.
<b>uuuu</b>	The process value is below the value that can be displayed.	

**10. INPUT TYPE - MEASUREMENT RANGE**

**TEMPERATURE SENSORS**

Sensor Type	Standart	Temperature Range	
		(°C)	(°F)
<b>b</b> Type B	IEC584-1	60, 1820	140, 3308
<b>E</b> Type E	IEC584-1	-200, 840	-328, 1544
<b>J</b> Type J	IEC584-1	-200, 1120	-328, 1562
<b>K</b> Type K	IEC584-1	-200, 1360	-328, 2480
<b>L</b> Type L	DIN43710	-200, 900	-328, 1652
<b>n</b> Type N	IEC584-1	-200, 1300	-328, 2372
<b>r</b> Type R	IEC584-1	-40, 1760	104, 3200
<b>S</b> Type S	IEC584-1	-40, 1760	104, 3200
<b>t</b> Type T	IEC584-1	-200, 400	-328, 752
<b>U</b> Type U	DIN43710	-200, 600	-328, 1112
<b>Pt</b> Pt100	IEC751	-200, 840	-328, 1544

**LINEAR INPUTS**

Type	Range
<b>0A20</b> Current	0-20 mA DC
<b>4A20</b> Current	4-20 mA DC
<b>0V50</b> Voltage	0-50 mV DC
<b>0.0V</b> Voltage	0-1 V DC
<b>0.2V</b> Voltage	0.2-1 V DC

**11. ALARM TYPES**

The alarm types for E-210 are as given below; where **n** is the alarm number;

$RnSP$	EXPLANATIONS		
	$RnSP > 0$	$RnSP < 0$	
<b>Lo</b>			Lower Bias (Absolute)
<b>Hi</b>			Upper Bias (Absolute)
<b>Lod</b>			Lower Bias (Relative)
<b>Hi d</b>			Upper Bias (Relative)
<b>Lob</b>			Internal Band Alarm
<b>Hi b</b>			Internal Band Alarm
<b>oFF</b>	Alarm function is cancelled when $RnSP$ parameter is <b>oFF</b> .		
<p>Shaded graphics show the hysteresis.</p> <p>For Alarm State, "1" is for relay is active and "0" is for relay inactive.</p>			

**12. AUTO-TUNE**

Autotune can be done when the control type is PID. Before the process, the set value and a small hysteresis value (to stop unstability) should be specified by the user.\*

(Figure 12.1) To start the Auto-tuning process, the  $Rt$  parameters should be  $on$ .

Time taken for auto-tuning, changes related to

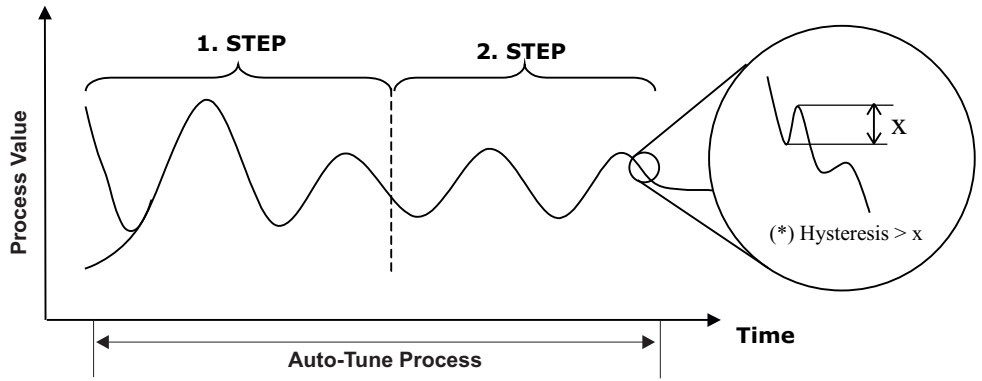
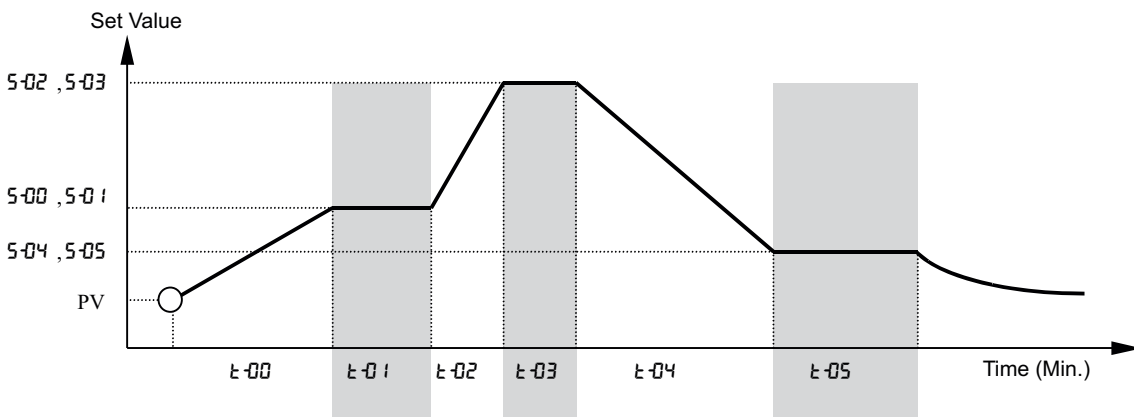

**Figure 12.1**

the capacity of the system that's controlled. During this process the MN Led and the Lower Display in front of the panel blinks. The  $Pb-1$ ,  $Pb-2$  and  $dt$  parameters specified by auto-tuning, are written and saved in EEPROM, and  $Rt$  parameter switches  $off$ . If the  $Rt$  parameter is made  $off$  during the auto-tuning, the process is cancelled. In the case of cancelled auto-tuning, the keeps working with the previously selected  $Pb-1$ ,  $Pb-2$ ,  $It$ ,  $dt$  values. Auto-tune process can also be observed from Figure 12.1.

**13. STEP-CONTROL PROGRAMS**

E-210 control instrument, accept as much as 100 steps, containing time and target set values, and 6 different warnings can be assigned (A, B, C, D, O, H) to these steps. If desired these warnings can be obtained over relays. 10 separate programs can be defined over these 100 steps, by entering the starting and the ending step numbers. A Program-Execution process, begins with the starting step and increasing, continues until the ending step number. If the ending step number is less than the starting step number, then the step number follows 0 after 99. Steps with  $0.0$  time are neglected. When running, pressing  $\blacktriangledown$  key, program holds and pressing  $\blacktriangle$  key program resumes. When holding, lower display blinks, indicating system is in Hold State.



**Figure13.1**



The explanations for the Step-Control Program Parameters are given below. The usage of these parameters are shown in **Figure 13.1**.

- The “*SPSr*” parameter in *SEtS* Page should be set to *PrFL*, in order to create and execute the Step-Control Programs.
- The “*SGdt*” Parameter in *SGno* Page, can take values of *00-99* and shows the step numbers to be programmed.
- The “*t-n*” parameter in *SGdt* Page determines the step type. Can have the values of *0.0-999.9* min.
- The “*S-n*” parameter in *SGdt* Page, determines the step ending number. Can have a value between the number determined by *SPLL* and *SPHL* parameters.
- The “*A-n*, *b-n*, *C-n*, *d-n*” parameters in *SGdt* Page determines if the *AL-A*, *AL-b*, *AL-C*, *AL-d* alarms should be active during the step time. Can be set *on* or *off*.
- The “*o-n*” parameter in the *SGdt* Page, determines if the difference between the process value and the set value is larger than *HYS*, and if the *AL-o* alarm should be set in the Hold State. Can be set *off* or *on*.
- The “*H-n*” parameter in the *SGdt* Page, determines if step beginning hold state should be achieved with *AL-H* alarm set. Can be set *off* or *on*.
- The “*SS-m*” parameter in the *Prdt* Page, determines the step-beginning number of the program, with values *0* to *99*.
- The “*ES-m*” parameter in *Prdt* Page, determines the step-end number, with values *0* to *99*.

## 14. FEEDBACK VALVE CONTROL

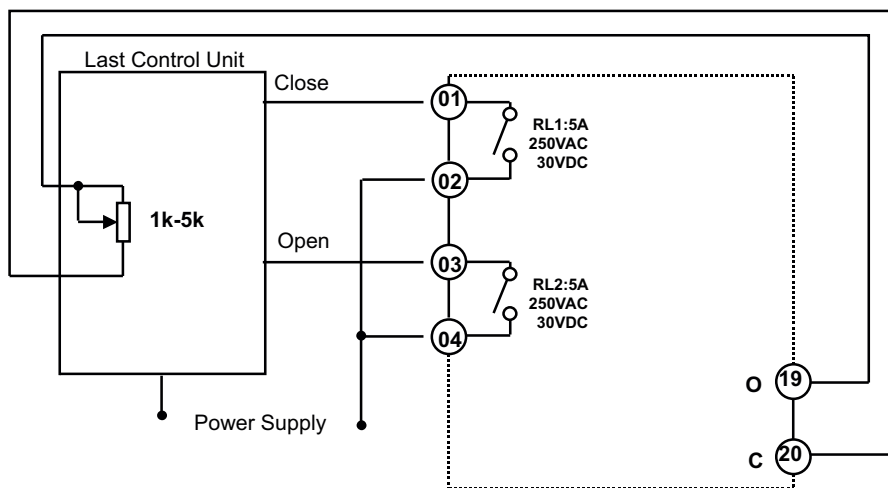

**Figure14.1**

As shown in **Figure 14.1**, control of the feedback controlled valve can be made, with a servomotor connected to the relays and the 19-20th clemenses on E-210, and a potantiometer(1k-5k)

The parameters of this control, are the  $\text{CtYP}$ ,  $\text{dbnd}$ ,  $\text{SruL}$  and  $\text{SruH}$  parameters, in the output configurations page  $\text{oCnF}$ . These parameters are as follows;

- The  $\text{CtYP}$  parameter should be set to  $\text{PFb}$ , for this control.
- The  $\text{dbnd}$  parameter is used to prevent relays from opening and closing frequently, during the control. Its unit is given as a percentage of the location data. Its value determines the Death Band value for both to stay open.
- The  $\text{SruL}$  parameter, keeps the location data of the controlled valve in the fully closed state. With this parameter on the display,  $\blacktriangledown$  key starts the action in motor-active direction. In the fully closed state, the value shown on the display can be saved by pressing  $\text{✖}\blacktriangledown$  keys
- The  $\text{SruH}$  parameters, keeps the location data of the controlled valve in the fully open state. With this parameter on the display,  $\blacktriangle$  key starts the action in the motor-active direction. In the fully active state, the value shown on the display can be saved by pressing  $\text{✖}\blacktriangledown$  keys.

## 15.OPEN-LOOP VALVE CONTROL

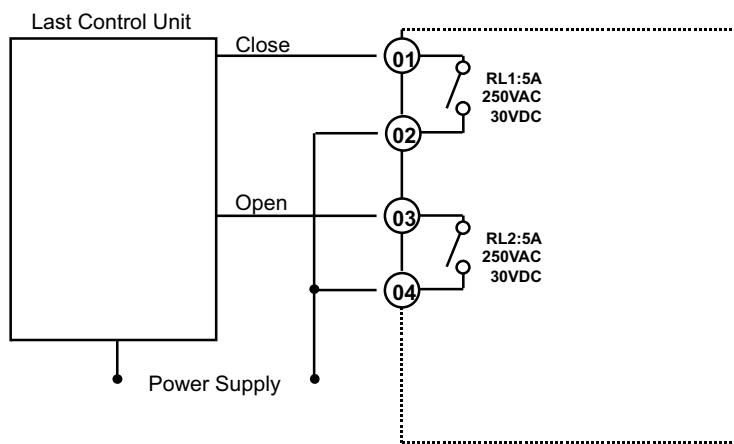

**Figure 15.1**

Using the relays on E-210, an open-loop valve control can be made, as shown in **Figure 15.1**. Parameters related with this control, are the  $\text{CtYP}$ ,  $\text{dbnd}$  ve  $\text{tTtñ}$  parameters in the  $\text{oCnF}$  Page. The explanation for the parameters are;

- For this control to be made, the  $\text{CtYP}$  parameters should be set to  $\text{bnd}$ .
- The  $\text{dbnd}$  parameter is used to prevent the relays from opening and closing frequently, during the control. Its unit is given as percentage of the location data. Its value determines the Death Band value for both relays to stay open.
- The  $\text{tTtñ}$  parameter is the time, in which the valve switches to full-closed from full-open state, when energized. Its unit is seconds.

## 16. OPERATION AND CONFIGURATION PAGES

When first starts, upper display shows the process value, lower display shows the set value or another control parameter, depending on the working mode. This screen is called Operation Screen. Together with the Operating Screen, the frequently used parameters are called the Operation Page. Can be reached with the  key. The parameters for main functions are determined in Configuration Page. Input for these pages are as shown below;

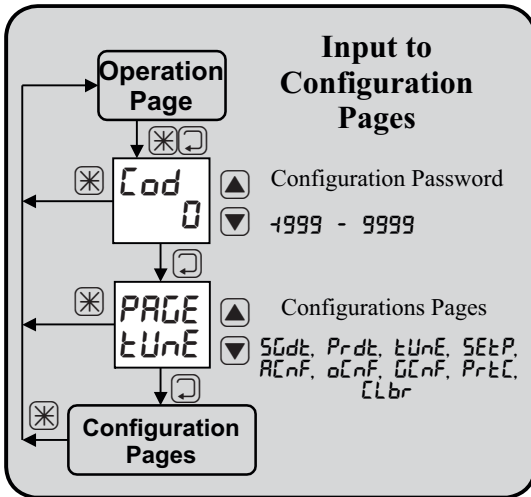

**Note:** Password for the configuration, is set to “10”, as a factory setting.

### Configuration Pages:



- SdEt* = Step Determination Page
- Prdt* = Program Determination Page
- tUnE* = PID Tuning Page
- SEtP* = Set Points Configuration Page
- REnF* = Alarm Configuration Page
- oEnF* = Control and Output Units Configuration Page
- GEnF* = General Configuration Page
- PrtE* = Security Adjustments Page
- LLbr* = Calibration Page

The explanations are given below.

**Note:** The EU (Engineering Unit) used in the tables, Thermocouples and resistance thermometer input type units °C or °F, and for linear inputs types, are the controller measurement unit.

**AUTOMATIC-MODE Operation Page**

Display	Explanation	Unit	Observation Conditions	Key	Key Function / Setting Interval
234 00	Process Value ( Operation Screen ) <sup>(1)</sup>	EU			
	Control Set Point	EU		▼ / ▲	SPLL - SPHL <sup>(2)</sup>
oUt 00	Control Output Value <sup>(3)</sup>	%	CLYP ≠ nonE		
PSP 00	Progressive Set Point	EU	SPrr ≠ oFF		
R1SP 00	Alarm-1 Set Point	EU	R1LP ≠ oFF	▼ / ▲	+999 - 9999
R2SP 00	Alarm-2 Set Point	EU	R2LP ≠ oFF	▼ / ▲	+999 - 9999
R3SP 00	Alarm-3 Set Point	EU	R3LP ≠ oFF	▼ / ▲	+999 - 9999
R4SP 00	Alarm-4 Set Point	EU	R4LP ≠ oFF	▼ / ▲	+999 - 9999

Within this screen, pressing  button, changes to the next screen, pressing  or 2s  returns to the Operation-Screen.

<sup>(1)</sup> In the Operation Screen.

Pressing  removes the RL -H, RL -E warnings.



If (  $\bar{n}Pr = Enb$  ) and  is pressed during at least 3 s, Manuel-Mode is entered.



<sup>(2)</sup> If the Set-Point-Source is external (  $SPSr \neq inE$  ), this adjustment is not valid.

<sup>(3)</sup> With the Control-Type as open-loop valve control (  $CLYP = bnd$  ), this screen is used for Valve-Direction, instead of Control-Output value. (  $SLP =$  Valve inactive ,  $CLS =$  Closing Valve ,  $oPn =$  Opening Valve )

**MANUEL-MODE Operation Page**

Display	Explanation	Unit	Observation Conditions	Key	Key Function /Setting Interval
23.4 50.0	Process Value ( Operation-Screen ) <sup>(1)</sup> Control Output Value	EU %	[tYP = SCo SingleSided (+) PID Control	▼ / ▲	SoLL - SoHL
23.4 50.0	Process Value ( Operation-Screen ) <sup>(1)</sup> Control Output Value	EU %	[tYP = dCo Double Sided(+/-) PID Control	▼ / ▲	doLL - doHL
23.4 50.0	Process Value ( Operation-Screen ) <sup>(1)</sup> Control Output Value	EU %	[tYP = Pfb Feedback Valve Control	▼ / ▲	SoLL - SoHL
23.4 StP	Process Value ( Operation-Screen ) <sup>(1)</sup> Valve Direction <sup>(2)</sup>	EU -	[tYP = bnd Open-Loop Valve Control	▼ / ▲	Valve-Close/ Valve-Open
R1SP 0.0	Alarm-1 Set Point	EU	R1tP ≠ oFF	▼ / ▲	1999 - 9999
R2SP 0.0	Alarm-2 Set Point	EU	R2tP ≠ oFF	▼ / ▲	1999 - 9999
R3SP 0.0	Alarm-3 Set Point	EU	R3tP ≠ oFF	▼ / ▲	1999 - 9999
R4SP 0.0	Alarm-4 Set Point	EU	R4tP ≠ oFF	▼ / ▲	1999 - 9999

Within this screen, pressing  button, changes to the next screen, pressing  or 2s  returns to the Operation-Screen.

<sup>(1)</sup> In the Operation-Screen,  
Pressing  removes the RL - H, RL - E warnings and locked alarms  
While in Manuel-Mode, pressing  during at least 3 s reverts to Automatic-Mode.

<sup>(2)</sup> StP = Valve inactive, CLS = Closing Valve, oPn = Opening Valve

**PROFILE-CONTROL Operation Page ( Program Not Running )**



Display	Explanation	Unit	Observation Conditions	Key	Key Function /Setting Interval
23.4 Pr-0	Process Value ( <b>Operation-Screen</b> ) <sup>(1)</sup> Number of the Program to be running	EU		⊗ / ▾ ▾ / ▲	Program-Start 0 - 9
rPt 1	Program Repeat Number (For Continuous enter Cont)			▾ / ▲	Cont. 1 - 250
R1SP 00	Alarm-1 Set Point	EU	R1tP ≠ oFF	▾ / ▲	1999 - 9999
R2SP 00	Alarm-2 Set Point	EU	R2tP ≠ oFF	▾ / ▲	1999 - 9999
R3SP 00	Alarm-3 Set Point	EU	R3tP ≠ oFF	▾ / ▲	1999 - 9999
R4SP 00	Alarm-4 Set Point	EU	R4tP ≠ oFF	▾ / ▲	1999 - 9999



Whitin this screen, pressing button, changes to the next screen, pressing or 2s returns to the Operation-Screen.

<sup>(1)</sup> In the Operation-Screen peratör.  
Pressing removes the RL -H, RL -E warnings and locked alarms.  
If  $\overline{nnPr=Enb}$  and is pressed during at least 3 s, Manuel- Mode is entered.

**PROFILE-CONTROL Operation Page ( Program is running )**

Display	Explanation	Unit	Observation Condition	Key	Key Function /Setting Interval
234 00	Process Value ( Operation-Screen ) <sup>(1)</sup>	EU		⊗▼	Program-Stop
	Control Set Point	EU		▼ / ▲	Program-Pause/ Continue
5-00 0.1	Step Number in Process			⊗▼ / ⊗▲	Step-Begin / Next-Step
	Time Left to Step-End	dk		▼ / ▲	Program-Hold /Continue
RPrg 0	Program Number in Process				
rrPt 1	Remaining Repeat Number ( Cont = Continuous )				
out 00	Control Output Value <sup>(2)</sup>	%			
PSP 00	Progressive Set Point	EU	SPrr ≠ oFF		
R1SP 00	Alarm-1 Set Point	EU	R1tP ≠ oFF	▼ / ▲	1999 - 9999
R2SP 00	Alarm-2 Set Point	EU	R2tP ≠ oFF	▼ / ▲	1999 - 9999
R3SP 00	Alarm-3 Set Point	EU	R3tP ≠ oFF	▼ / ▲	1999 - 9999
R4SP 00	Alarm-4 Set Point	EU	R4tP ≠ oFF	▼ / ▲	1999 - 9999





Within this screen, pressing  button, changes to the next screen, pressing  or 2s  returns to the Operation-Screen.

<sup>(1)</sup> In the Operation-Screen .  
Pressing  removes the RL -H, RL -E warnings and locked alarms.  
If (nnPr = Enb) and  is pressed during at least 3 s, Manuel-Mode is entered.

<sup>(2)</sup> With Control-Type as open-loop valve control ( CLYP = bnd ), this screen is used for Valve-Direction, instead of Control-Output value.  
( StP = Valve inactive , CLS = Closing Valve , oPn =Opening Valve )

Step Determination Page( PAGE = 50dt )



Display	Explanation	Unit	Observation Conditions	Key	Key Function / Setting Interval
50no 0	Step Number to be Programmed		SP5r = PrFL	▼ / ▲	0 - 99
t-00 0.1	Step Number Step Time ( Enter 00 to cancel the step )	Min.	SP5r = PrFL	※▼ / ※▲ ▼ / ▲	0 - 99 00 - 9999
S-00 00	Step Number Step-end Set Value	EU	SP5r = PrFL	※▼ / ※▲ ▼ / ▲	0 - 99 SPLL - SPHL
R-00 off	Step Number "RL -R" Alarm, during the Step	Table-7	SP5r = PrFL	※▼ / ※▲ ▼ / ▲	0 - 99 Table-7
b-00 off	Step Number "RL -b" Alarm, during the Step	Table-7	SP5r = PrFL	※▼ / ※▲ ▼ / ▲	0 - 99 Table-7
c-00 off	Step Number "RL -c" Alarm, during the Step	Table-7	SP5r = PrFL	※▼ / ※▲ ▼ / ▲	0 - 99 Table-7
d-00 off	Step Number "RL -d" Alarm, during the Step	Table-7	SP5r = PrFL	※▼ / ※▲ ▼ / ▲	0 - 99 Table-7
o-00 off	Step Number Hold in case of Excess Value and give "RL -o" Alarm	Table-7	SP5r = PrFL	※▼ / ※▲ ▼ / ▲	0 - 99 Table-7
H-00 off	Step Number Hold with Step-Begin and give "RL -H" Alarm	Table-7	SP5r = PrFL	※▼ / ※▲ ▼ / ▲	0 - 99 Table-7

Within this screen, pressing  button, changes to the next screen, pressing 2s  or  returns to the Operation-Screen  
While this parameter is selected, pressing  increments the 50no and returns to 50no parameters.





Program Determination Page ( *PRGE = PrdL* )

Display	Explanation	Unit	Observation Conditions	Key	Key Function / Setting Interval
SS-0 0	Program-0 Start Step Number		SP5r = PrFL	▼ / ▲	0 - 99
ES-0 0	Program-0 End Step Number		SP5r = PrFL	▼ / ▲	0 - 99
SS-1 0	Program-1 Start Step Number		SP5r = PrFL	▼ / ▲	0 - 99
ES-1 0	Program-1 End Step Number		SP5r = PrFL	▼ / ▲	0 - 99
SS-2 0	Program-2 Start Step Number		SP5r = PrFL	▼ / ▲	0 - 99
ES-2 0	Program-2 End Step Number		SP5r = PrFL	▼ / ▲	0 - 99
SS-3 0	Program-3 Start Step Number		SP5r = PrFL	▼ / ▲	0 - 99
ES-3 0	Program-3 End Step Number		SP5r = PrFL	▼ / ▲	0 - 99
SS-4 0	Program-4 Start Step Number		SP5r = PrFL	▼ / ▲	0 - 99
ES-4 0	Program-4 End Step Number		SP5r = PrFL	▼ / ▲	0 - 99
SS-5 0	Program-5 Start Step Number		SP5r = PrFL	▼ / ▲	0 - 99
ES-5 0	Program-5 End Step Number		SP5r = PrFL	▼ / ▲	0 - 99
SS-6 0	Program-6 Start Step Number		SP5r = PrFL	▼ / ▲	0 - 99
ES-6 0	Program-6 End Step Number		SP5r = PrFL	▼ / ▲	0 - 99
SS-7 0	Program-7 Start Step Number		SP5r = PrFL	▼ / ▲	0 - 99
ES-7 0	Program-7 End Step Number		SP5r = PrFL	▼ / ▲	0 - 99
SS-8 0	Program-8 Start Step Number		SP5r = PrFL	▼ / ▲	0 - 99
ES-8 0	Program-8 End Step Number		SP5r = PrFL	▼ / ▲	0 - 99
SS-9 0	Program-9 Start Step Number		SP5r = PrFL	▼ / ▲	0 - 99
ES-9 0	Program-9 End Step Number		SP5r = PrFL	▼ / ▲	0 - 99

Within this screen, pressing  button, changes to the next screen, pressing  or 2s  returns to the Operation-Screen.

PID Tuning Page ( *PRGE = tUnE* )



Display	Explanation	Unit	Observation Conditions	Key	Key Function /Setting Interval
<i>Rt</i> <i>oFF</i>	Auto-Tune <sup>(1)</sup>	Table-7	[tYP ≠ nonE [tYP ≠ bnd	▼ / ▲	Table-7 <sup>(1)</sup>
<i>Pb-1</i> <i>20.0</i>	Proportional-Band-1 (For "+" Directed Control Outputs)	EU	[tYP ≠ nonE	▼ / ▲	0.1 - 9999
<i>Pb-2</i> <i>20.0</i>	Proportional-Band-2 (For "-" Directed Control Output )	EU	[tYP = dCo	▼ / ▲	0.1 - 9999
<i>It</i> <i>28</i>	Integral Time ( If "oFF" integral is inactive )	s	[tYP ≠ nonE	▼ / ▲	oFF, 1 - 9999
<i>dt</i> <i>7</i>	Derivative Time ( If "oFF", Derivative is inactive )	s	[tYP ≠ nonE	▼ / ▲	oFF, 1 - 2500
<i>HYS</i> <i>0.1</i>	Hysteresis	EU		▼ / ▲	0.0 - 9999

Within this screen, pressing  button, changes to the next screen, pressing  or 2s  returns to the Operation-Screen.

<sup>(1)</sup> Auto-Tune Function can not start in Manuel-Mode.



Set Points Configuration Page ( PAGE = SEtP )

Display	Explanation	Unit	Observation Conditions	Key	Key Function/ Setting Interval
SP5r int	Set Point Source	Table-13		▼ / ▲	Table-13
SPLL 1999	Set Point Lower Limit	EU		▼ / ▲	1999 - SPHL
SPHL 9999	Set Point Upper Limit	EU		▼ / ▲	SPLL - 9999
SPrr 00	Set Point Ramping Rate (For fastest change, enter "oFF")	EU/min		▼ / ▲	oFF, 0.1 - 600
SEt1 00	1.Multiple Set Point	EU	SP5r = d inP	▼ / ▲	SPLL - SPHL
SEt2 00	2.Multiple Set Point	EU	SP5r = d inP	▼ / ▲	SPLL - SPHL
SEt3 00	3.Multiple Set Point	EU	SP5r = d inP	▼ / ▲	SPLL - SPHL
SEt4 00	4.Multiple Set Point	EU	SP5r = d inP	▼ / ▲	SPLL - SPHL
PonP 0	Profile-Control Power-On Behaviour	Table-21	SP5r = PrFL	▼ / ▲	Table-21

Within this screen, pressing  button, changes to the next screen, pressing  or 2s  returns to the Operation-Screen.

Alarm Configuration Page ( PAGE = RLnF )

Display	Explanation	Unit	Observation Conditions	Key	Key Function /Setting Interval
R1tP oFF	Alarm-1 Type	Table-11		▼ / ▲	Table-11
R1HY 0.5	Alarm-1 Hysteresis	EU	R1tP ≠ oFF	▼ / ▲	00 - 9999
R1Lt d5b	Alarm-1 Lock	Table-6	R1tP ≠ oFF	▼ / ▲	Table-6
R2tP oFF	Alarm-2 Type	Table-11		▼ / ▲	Table-11
R2HY 0.5	Alarm-2 Hysteresis	EU	R2tP ≠ oFF	▼ / ▲	00 - 9999
R2Lt d5b	Alarm-2 Lock	Table-6	R2tP ≠ oFF	▼ / ▲	Table-6
R3tP oFF	Alarm-3 Type	Table-11		▼ / ▲	Table-11
R3HY 0.5	Alarm-3 Hysteresis	EU	R3tP ≠ oFF	▼ / ▲	00 - 9999
R3Lt d5b	Alarm-3 Lock	Table-6	R3tP ≠ oFF	▼ / ▲	Table-6
R4tP oFF	Alarm-4 Type	Table-11		▼ / ▲	Table-11
R4HY 0.5	Alarm-4 Hysteresis	EU	R4tP ≠ oFF	▼ / ▲	00 - 9999
R4Lt d5b	Alarm-4 Lock	Table-6	R4tP ≠ oFF	▼ / ▲	Table-6

Within this screen, pressing  button, changes to the next screen, pressing  or 2s  returns to the Operation-Screen.



Control and Output Unit Configuration Page (PAGE = oCnF)

Display	Explanation	Unit	Observation Conditions	Key	Key Function / Setting Interval
ctYP SCo	Control Type	Table-12		▼ / ▲	Table-12
CFrñ rEu	Control Form	Table-8	ctYP ≠ nonE	▼ / ▲	Table-8
CPrd 2	Control Period	s	ctYP ≠ nonE	▼ / ▲	1 - 250
ñnPr dSb	Manuel Operation Permission	Table-6	ctYP ≠ nonE	▼ / ▲	Table-6
trtñ 100	Motor Valve Travel Time	s	ctYP = bnd	▼ / ▲	10 - 2500
dbnd 0.5	Control Output Death Band	%	ctYP ≠ nonE	▼ / ▲	0.1 - 250
SoLL 00	Single Sided (+) Control Output Lower Limit	%	ctYP ≠ nonE ctYP ≠ dCo	▼ / ▲	00 - 50ñr
SoHL 1000	Single Sided (+) Control Output Upper Limit	%	ctYP ≠ nonE ctYP ≠ dCo	▼ / ▲	50ñr - 1000
50ñr 500	Single Sided (+) Control Output Manuel-Reset Value	%	ctYP ≠ nonE ctYP ≠ dCo	▼ / ▲	SoLL - SoHL
doLL 1000	Double Sided (+/-) Control Output Lower Limit	%	ctYP = dCo	▼ / ▲	1000 - doñr
doHL 1000	Double Sided (+/-) Control Output Upper Limit	%	ctYP = dCo	▼ / ▲	doñr - 1000
doñr 00	Double Sided (+/-) Control Output Manuel-Reset Value	%	ctYP = dCo	▼ / ▲	doLL - doHL
PonC 0	PID Control Power-On Behaviour	Table-20	ctYP ≠ nonE	▼ / ▲	Table-20
rL1d Co-1	1.Relay ( RL1 ) Function	Table-10		▼ / ▲	Table-10
rL2d Co-2	2.Relay ( RL2 ) Function	Table-10		▼ / ▲	Table-10
rL3d RL-3	3.Relay ( RL3 ) Function	Table-10		▼ / ▲	Table-10
rL4d RL-4	4.Relay ( RL4 ) Function	Table-10		▼ / ▲	Table-10
Ro1d Co-1	1.Analog Output ( AO1 ) Function	Table-14		▼ / ▲	Table-14
Ro2d Co-2	2.Analog Output ( AO2 ) Function	Table-14		▼ / ▲	Table-14
Ro1r 4-20	1.Analog Output ( AO1 ) Scalar	Table-15		▼ / ▲	Table-15
Ro2r 4-20	2.Analog Output ( AO2 ) Scalar	Table-15		▼ / ▲	Table-15
SruL 1889	Motor-Valve Fully-Closed Position		ctYP = PFb	⊗▼ ▼ / ▲	Save Position Valve-Close / Valve-Open
SruH 3756	Motor-Valve Fully-Open Position		ctYP = PFb	⊗▼ ▼ / ▲	Save Position Valve-Close / Valve-Open

Within this screen, pressing button, changes to the next screen, pressing or 2s returns to the Operation-Screen.

General Configuration Page (PAGE = GENF)

Display	Explanation	Unit	Observation Conditions	Key	Key Function /Setting Interval
inP1 1	1.Analog Input (AIN1 ) Type ( For Process Value Measurement)	Table-17		▼ / ▲	Table-17
inP2 4920	2.Analog Input (AIN2 ) Type ( External Set Point Input )	Table-5		▼ / ▲	Table-5
dP 1	Measurement Decimal Point ( DP ) <sup>(1)</sup>			▼ / ▲	0 - 3
2Er0 00	Analog Input Scale Lower Value ( Linear Input Types )	EU		▼ / ▲	1999 - 9999
5PAn 4000	Analog Input Scale Upper Value ( Linear Input Types )	EU		▼ / ▲	1999 - 9999
ErLL 00	Transmitter Scale Lower Value	EU		▼ / ▲	1999 - ErHL
ErHL 4000	Transmitter Scale Upper Value	EU		▼ / ▲	ErLL - 9999
Unit °C	Temperature Unit	Table-9	inP i = TC / RT	▼ / ▲	Table-9
oFSt 00	Temperature Offset Value	EU	inP i = TC / RT	▼ / ▲	1000 - 1000
FLtr 05	Measurement Filter Coefficient	EU		▼ / ▲	0.1 - 100
Snbr H1	Sensor Broken Behaviour	Table-4		▼ / ▲	Table-4
AdrS 1	Communication Address			▼ / ▲	1 - 127
brtE 48	Bound Rate ( 48, 96, 192, 384 )	Kb/s		▼ / ▲	48, 96, 192, 384
Prty EunE	Parity	Table-16		▼ / ▲	Table-16

Within this screen, pressing  button, changes to the next screen, pressing  or 2s  returns to the Operation-Screen.

<sup>(1)</sup> Measurement Decimal Point ( DP ) is specified by the dP Parameter. But If 1.Analog Input Type ( inP i ) is TC or RT and the dP parameter is greater than "1", ( DP ) = 1" assumed. When the dP Parameter is changed, all the parameters with EU unit should be readjusted.



Security Adjustments Page ( PAGE = PrtL )

Display	Explanation	Unit	Observation Conditions	Key	Key Function / Setting Interval
SCod 10	Configuration Password Set Point			▼ / ▲	1999 - 9999
Artn oFF	Menu Auto-Exit Time (cancelled if oFF )	s		▼ / ▲	oFF, 5 - 25
dPrL 5	Operator, Configuration Follow Level	Table-18		▼ / ▲	Table-18
APrL 2	Operator, Configuration Change Level	Table-19		▼ / ▲	Table-19
CPrL dSb	Calibration Page Input Permission	Table-6		▼ / ▲	Table-6
FCSt oFF	Return to Factory Settings	Table-7		⊗▼	Approval
				▼ / ▲	Table-7

Within this screen, pressing □ button, changes to the next screen, pressing ⊗ or 2s □ returns to the Operation-Screen.

Calibration Page ( PAGE = CLbr )

Display	Explanation	Unit	Observation Conditions	Key	Key Function / Setting Interval
50.0u 6832	1.Analog Input ( AIN1 ) 50mV Calibration			⊗▼	Save Calibration Value
0.0°C 83	1.Analog Input ( AIN1 ) 0.0°C Calibration ( with Type-K TC )			⊗▼	Save Calibration Value
390.0 6545	1.Analog Input ( AIN1 ) 390Ω Calibration			⊗▼	Save Calibration Value
20.0A 8845	1.Analog Input ( AIN1 ) 20mA Calibration			⊗▼	Save Calibration Value
10.2H 8784	2.Analog Input ( AIN2 ) 20mA Calibration			⊗▼	Save Calibration Value
AO 1L 1600	1.Analog Output ( AO1 ) 4mA Calibration			▼ / ▲	1300 - 3000
AO 1H 7400	1.Analog Output ( AO1 ) 20mA Calibration			▼ / ▲	6500 - 8191
AO 2L 1600	2.Analog Output ( AO2 ) 4mA Calibration			▼ / ▲	1300 - 3000
AO 2H 7400	2.Analog Output ( AO2 ) 20mA Calibration			▼ / ▲	6500 - 8191

Within this screen, pressing  button, changes to the next screen, pressing  or 2s  returns to the Operation-Screen.



E-210 Communication Data

Address	In Short	Explanation	Unit	Multiplier	Adjustment Permit	Min.	Max.
0		Status	Table-1		No	0	0
1		Reserve			No	0	0
2		Process Value	EU	10 <sup>^</sup> DP	No	0	0
3	PSP	Progressive Set Point	EU	10 <sup>^</sup> DP	No	0	0
4	RPn	Active Program Number			No	0	0
5	rrPt	Remaining Repeat Number ( 0 = Continuous )		10 <sup>^</sup> DP	No	0	0
6		Active Step Number			No	0	0
7		Step-End Time	Min.	10	No	0	0
8		Measurement Decimal Point			No	0	0
9	SPSr	Set Point Source	Table-13		No	0	0
10	CTYP	Control Type	Table-12		No	0	0
11	OUT	Control Output Value	%	10	Yes	-1000	1000
12		Control Set Point	EU	10 <sup>^</sup> DP	Yes	-1999	9999
13	At	Auto-Tune	Table-7		Yes	0	1
14		Program Number to be Running			Yes	0	9
15	rPt	Program Repeat Number (For Continuous enter "0" )			Yes	0	250

16	SS-0	Program-0 Beginning Step Number			Yes	0	99
17	ES-0	Program-0 Last Step Number			Yes	0	99
18	SS-1	Program-1 Beginning Step Number			Yes	0	99
19	ES-1	Program-1 Last Step Number			Yes	0	99
20	SS-2	Program-2 Beginning Step Number			Yes	0	99
21	ES-2	Program-2 Last Step Number			Yes	0	99
22	SS-3	Program-3 Beginning Step Number			Yes	0	99
23	ES-3	Program-3 Last Step Number			Yes	0	99
24	SS-4	Program-4 Beginning Step Number			Yes	0	99
25	ES-4	Program-4 Last Step Number			Yes	0	99
26	SS-5	Program-5 Beginning Step Number			Yes	0	99
27	ES-5	Program-5 Last Step Number			Yes	0	99
28	SS-6	Program-6 Beginning Step Number			Yes	0	99
29	ES-6	Program-6 Last Step Number			Yes	0	99
30	SS-7	Program-7 Beginning Step Number			Yes	0	99
31	ES-7	Program-7 Last Step Number			Yes	0	99
32	SS-8	Program-8 Beginning Step Number			Yes	0	99
33	ES-8	Program-8 Last Step Number			Yes	0	99
34	SS-9	Program-9 Beginning Step Number			Yes	0	99
35	ES-9	Program-9 Last Step Number			Yes	0	99

36	Pb-1	Proportional Band-1 ( "+" Directed Control Output )	EU	10 <sup>^</sup> DP	Yes	1	9999
37	Pb-2	Proportional Band-2 ( "-" Directed Control Output )	EU	10 <sup>^</sup> DP	Yes	1	9999
38	It	Time of Integral (If "0", Integral is inactive )	s		Yes	0	9999
39	dT	Time of Derivative (If "0", Derivative is inactive )	s		Yes	0	2500
40	HY5	Hysteresis	EU	10 <sup>^</sup> DP	Yes	0	9999

41	SPSr	Set Point Source	Table-13		Yes	0	3
42	SPLL	Set Point Lower Limit	EU	10 <sup>^</sup> DP	Yes	-1999	9999
43	SPHL	Set Point Upper Limit	EU	10 <sup>^</sup> DP	Yes	-1999	9999
44	SPrr	Set Point Ramping Rate (For Fastest 0 = En Hızlı )	EU/dk	10 <sup>^</sup> DP	Yes	0	600
45	nSP1	1.Multiple Set Point	EU	10 <sup>^</sup> DP	Yes	-1999	9999
46	nSP2	2.Multiple Set Point	EU	10 <sup>^</sup> DP	Yes	-1999	9999
47	nSP3	3.Multiple Set Point	EU	10 <sup>^</sup> DP	Yes	-1999	9999
48	nSP4	4.Multiple Set Point	EU	10 <sup>^</sup> DP	Yes	-1999	9999
49	PonP	Profile-Control Power-On Behaviour	Table-21		Yes	0	4

Address	In Short	Explanation	Unit	Multiple	Adjustment Permit	Min.	Max.
50	R1LP	Alarm-1 Type	Table-11		Yes	0	6
51	R1HY	Alarm "1" Hysteresis Value	EU	10^DP	Yes	0	9999
52	R1LT	Alarm "1" Lock	Table-6		Yes	0	1
53	R1SP	Alarm "1" Set Point	EU	10^DP	Yes	-1999	9999
54	R2LP	Alarm "2" Type	Table-11		Yes	0	6
55	R2HY	Alarm "2" Hysteresis Value	EU	10^DP	Yes	0	9999
56	R2LT	Alarm "2" Lock	Table-6		Yes	0	1
57	R2SP	Alarm "2" Set Point	EU	10^DP	Yes	-1999	9999
58	R3LP	Alarm "3" Type	Table-11		Yes	0	6
59	R3HY	Alarm "3" Hysteresis Value	EU	10^DP	Yes	0	9999
60	R3LT	Alarm "3" Lock	Table-6		Yes	0	1
61	R3SP	Alarm "3" Set Point	EU	10^DP	Yes	-1999	9999
62	R4LP	Alarm "4" Type	Table-11		Yes	0	6
63	R4HY	Alarm "4" Hysteresis Value	EU	10^DP	Yes	0	9999
64	R4LT	Alarm "4" Lock	Table-6		Yes	0	1
65	R4SP	Alarm "4" Set Point	EU	10^DP	Yes	-1999	9999
66	CTYP	Control Type	Table-12		Yes	0	4
67	CFRN	Control Form	Table-8		Yes	0	1
68	CPRD	Control Period	s		Yes	1	250
69	NOPR	Manuel Operation Permisson	Table-6		Yes	0	1
70	TRTN	Motor Valve Travel Time	s		Yes	10	2500
71	DBND	Control Output Death Band	%	10	Yes	1	250
72	SO LL	Single Sided (+) Control Output Lower Limit	%	10	Yes	0	1000
73	SO HL	Single Sided (+) Control Output Upper Limit	%	10	Yes	0	1000
74	SO NR	Single Sided (+) Control Output Manual-Reset Value	%	10	Yes	0	1000
75	DO LL	Double Sided (+/-) Control Output Lower Limit	%	10	Yes	-1000	1000
76	DO HL	Double Sided (+/-) Control Output Upper Limit	%	10	Yes	-1000	1000
77	DO NR	Double Sided (+/-) Control Output Manual-Reset Value	%	10	Yes	-1000	1000
78	PONC	PID Control Power-On Behaviour	Table-20		Yes	0	4
79	RL1d	1.Relay (RL1) Function	Table-10		Yes	0	14
80	RL2d	2.Relay (RL2) Function	Table-10		Yes	0	14
81	RL3d	3.Relay (RL3) Function	Table-10		Yes	0	14
82	RL4d	4.Relay (RL4) Function	Table-10		Yes	0	14
83	AO1d	1.Analog Output (AO1) Function	Table-14		Yes	0	3
84	AO2d	2.Analog Output (AO2) Function	Table-14		Yes	0	3
85	AO1r	1.Analog Output (AO1) Scalar	Table-15		Yes	0	3
86	AO2r	2.Analog Output (AO2) Scalar	Table-15		Yes	0	3
87	AINP1	1.Analog Input (AIN1) Type (For Process Value Measurement )	Table-17		Yes	0	15
88	AINP2	2.Analog Input (AIN2) Type ( External Set Point Input )	Table-5		Yes	0	1
89	DP	Measurement Decimal Point ( DP ) <sup>(1)</sup>			Yes	0	3
90	ZEro	Analog Input Scalar Lower Value ( Linear Input Types )	EU	10^DP	Yes	-1999	9999
91	SPRn	Analog Input Scalar Upper Value ( Linear Input Types )	EU	10^DP	Yes	-1999	9999
92	TRLL	Transmitter Scale Lower Value	EU	10^DP	Yes	-1999	9999
93	TRHL	Transmitter Scale Upper Value	EU	10^DP	Yes	-1999	9999
94	UNIT	Temperature Unit	Table-9		Yes	0	1
95	OFSt	Temperature Offset Value	EU	10^DP	Yes	-1000	1000
96	FLTR	Measurement Filter Coefficient	EU	10^DP	Yes	1	100
97	SNBR	Sensor Broken Behaviour	Table-4		Yes	0	1
200+4n		Step Time ( "0" to cancel )	Min.	10	Yes	0	9999
201+4n		Step-End Set Value	EU	10^DP	Yes	-1999	9999
202+4n		Step Alarms	Table-2		Yes	0	63

Note : "n" is the step number, takes values between 0 and 99.

<sup>(1)</sup> Measurement Decimal Point ( DP ) is specified by the dP Parameter. But if 1.Analog Input Type ( INP1 ) is TC or RT and the dP parameter is greater than "1", ( DP ) = 1" assumed. When the dP Parameter is changed, all the parameters with EU unit should be readjusted.

**Tables:**

**Table-1**

Status		
Bit	In short	Explanation (For 1)
0		1.Relay ( RL1 ) Active
1		2.Relay ( RL2 ) Active
2		3.Relay ( RL3 ) Active
3		4.Relay ( RL4 ) Active
4	oPE <sub>n</sub>	Sensor Broken
5	oFL	Sensor Measurement over Scalar
6	uFL	Sensor Measurement below Scalar
7		Manuel
8	oP <sub>n</sub>	Valve Open
9	CL5	Valve Close
10		Program in Process
11		Program in Hold

**Table-2**

Step Alarms		
Bit	1 / 0 = Yes /No	
0		Give "RL -R" Alarm, during the Step
1		Give "RL -b" Alarm, during the Step
2		Give "RL -C" Alarm, during the Step
3		Give "RL -d" Alarm, during the Step
4		For Excess Change Hold and give "RL -o" Alarm
5		At Step Beginning Hold and give "RL -H" Alarm

**Table-3**

COILCommunication Addresses		
Ad.	A.Perm	Explanation ( 1 / 0 )
0	Yes	Mod ( Manuel / Automatic)
1	Yes	Valve ( Open /Stop )
2	Yes	Valve ( Close / Stop )
3	Yes	Program ( Start /Stop )
4	Var	Program ( Hold / Continue )

**Table-4**

0	Lo	Lower The Process Value
1	Hi	Higher The Process Value

**Table-5**

0	0R20	0-20mA ( Linear )
1	4R20	4-20mA ( Linear )

**Table-6**

0	d5b	Disable
1	Enb	Enable

**Table-7**

0	oFF	OFF
1	oN	ON

**Table-8**

0	dIr	Direct
1	rEu	Reverse

**Table-9**

0	oC	°C
1	oF	°F

**Table-10**

0	Co-1	"+" Directed Control Output
1	Co-2	"-" Directed Control Output
2	do-1	On / Off Heater Output
3	do-2	On / Off Cooler Output
4	RL-1	Alarm-1
5	RL-2	Alarm-2
6	RL-3	Alarm-3
7	RL-4	Alarm-4
8	RL-R	"A" Type Step Alarm
9	RL-b	"B" Type Step Alarm
10	RL-C	"C" Type Step Alarm
11	RL-d	"D" Type Step Alarm
12	RL-o	"O" Type Step Alarm
13	RL-H	"H" Type Step Alarm
14	RL-E	Program Over Alarm

**Table-11**

0	oFF	Off
1	Lo	Low (Absolute)
2	Hi	High (Absolute)
3	LoD	Low (Relative)
4	HiD	High (Relative)
5	LoB	Internal Band Alarm
6	HiB	External Band Alarm

**Table-12**

0	nonE	No Control
1	5Lo	Single-Sided (+) PID Control
2	dLo	Double-Sided (+/-) PID Control
3	Pfb	Feedback Valve Control
4	bnd	Open-Loop Valve Control

**Table-13**

0	int	Over The Unit or by Communication
1	E <sub>2</sub>	Over the 2.Analog Output( AIN2 )
2	dInP	Multiple with Digital Input (Tablo-22)
3	PrFL	With Profile-Control Program

**Table-14**

0	Co-1	"+"Directed Control Output
1	Co-2	"-" Directed Control Output
2	PvTr	Process Value Transmitter
3	SPTr	Set Point Transmitter

**Table-15**

0	0-20	0-20mA
1	20-0	20-0mA
2	4-20	4-20mA
3	20-4	20-4mA

**Table-16**

0	nonE	None
1	odd	Odd
2	EuEn	Even

**Table-17**

0	b	Type-B (TC)
1	E	Type-E (TC)
2	J	Type-J (TC)
3	K	Type-K (TC)
4	L	Type-L (TC)
5	n	Type-N (TC)
6	r	Type-R (TC)
7	S	Type-S (TC)
8	t	Type-T (TC)
9	U	Type-U (TC)
10	Pt	Pt-100 (RT)
11	0R20	0-20mA (Linear)
12	4R20	4-20mA (Linear)
13	0u50	0-50mV (Linear)
14	0.0u1	0.0-1.0V (Linear)
15	0.2u1	0.2-1.0V (Linear)

**Table-18 ( Not-1 )**

0	Only Process Value can be Observed	
1	Process and Set Values can be Observed	
2	Operation Screen Parameters can be Observed	
3	5Gdt	Page Parameters can be Observed
4	Prdt	Page Parameters can be Observed
5	tUnE	Page Parameters can be Observed
6	SEtP	Page Parameters can be Observed
7	RLnF	Page Parameters can be Observed
8	oLnF	Page Parameters can be Observed
9	CLnF	Page Parameters can be Observed

**Table-19 ( Not-1 )**

0	None of the Parameters can be changed	
1	Only Set Value can be changed	
2	Operation Screen Parameters can be changed	
3	5Gdt	Page Parameters can be changed
4	Prdt	Page Parameters can be changed
5	tUnE	Page Parameters can be changed
6	SEtP	Page Parameters can be changed
7	RLnF	Page Parameters can be changed
8	oLnF	Page Parameters can be changed
9	CLnF	Page Parameters can be changed

**Table-20**

0	Run with the latest Control Values	
1	Switch to Automatic Mode	
2	Switch to Automatic Mode and make "int=0"	
3	Switch to Manuel Mode	
4	Switch to Manuel Mode and make "Out = 0"	

**Table-21**

0	Profile Position Unchanged	
1	Profile Position Unchanged and Hold	
2	Return to the Start of the Current Segment	
3	Return to the Start of the Current Segment and Hold	
4	Stop	

**Table-22**

D11	D12	0 / 1 = Open/ Closeed
0	0	1.Multiple Set Point ( 5Et1 )
0	1	2.Multiple Set Point ( 5Et2 )
1	0	3.Multiple Set Point ( 5Et3 )
1	1	4.Multiple Set Point ( 5Et4 )

**Not-1:** Levels with large numerals in Tables-18 and Tables-19 contains previous levels