

E-48P

E-72P

E-96P

**PROCESS CONTROLLERS
GENERAL USER MANUAL**

CONTENTS

| | |
|--|----|
| 1. DEFINITION | 3 |
| 1.1. Front Panel Keys and Led Indicators | 3 |
| 2. POWER ON AND CONTROL MODES | 5 |
| 3. FRONT PANEL KEYS AND PROGRAMMING | 5 |
| 3.1. Process Screen and Operation Parameters | 7 |
| 3.2. Accessing Configuration Pages | 9 |
| 3.3. General Configuration Page (<i>ГЛНФ</i>) | 10 |
| 3.4. Control Set Point Configuration (<i>5ЕтР</i>) | 13 |
| 3.5. Alarm Configuration Page (<i>РЛнФ</i>) | 16 |
| 3.6. Output Configuration Page (<i>оЛнФ</i>) | 18 |
| 3.7. PID Configuration Page (<i>тУнЕ</i>) | 21 |
| 3.8. Security Configuration Page (<i>РrтЕ</i>) | 24 |
| 4. CONFIGURATION STEPS AND APPLICATIONS | 26 |
| 4.1. Use as a Single Output PID Controller. | 27 |
| 4.2. Use as a Dual Output PID Controller (HEAT/COOL) | 27 |
| 4.3. Valve Control without Feedback (Floating Control) | 28 |
| 4.4. Feedback Valve Control (Servo Feedback) | 28 |
| 5. MODBUS COMMUNICATION INFORMATION | 29 |

1. INTRODUCTION

This user manual is released for

E-48P, E-72P, E-96P

series controllers and contains detailed information about common features and common parameter explanations. Depending on the controller, some parameters may not exist because of different hardware and IO properties.

Please refer to the quick user manual shipped with the controller for device specific dimension, panel mounting, connection diagram, and technical specification.

These universal industrial process controllers have ON/OFF, single PID, Heat/Cool PID, feedback valve control, and floating valve control capabilities which are powered by new generation micro controllers. Universal inputs (T/C, R/T, mV, mA) and outputs are easily configurable with front panel keys.

All controllers have two 4 digit segment displays on which measurement and set values in the range of -1999 to 9999 are displayed.

1.1 Front Panel Keys ve LED Indicators

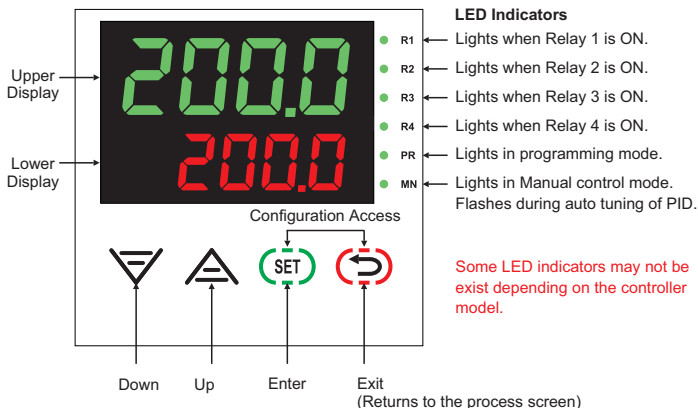

2. POWER ON AND CONTROL MODES

During first couple of seconds after power on, all segments and LED indicators light. After that, upper display shows controller model and lower display shows firmware version for a duration of 3 seconds and eventually Process Screen are displayed.

Consecutive pressing of (SET) key toggles between Process Screen and several operation parameter screens. Pressing (ESC) key returns to the Process Screen.

The controllers have two control modes as Automatic and Manual. To change the control mode, (ESC) key is pressed for at least 3 seconds at the Process Screen. (Only functional when $ocnF \rightarrow \bar{n}nPr$ (**Manual Mod Selection**) = $\bar{E}nb$).

User can make control operation inactive by selecting $ocnF \rightarrow c\bar{t}YP$ (**Control Type**) = $n\bar{o}n\bar{E}$ and by this way, the controller can be used as a process display and alarm device.

While in **Automatic Control Mode**, control output is calculated by the controller where as in **Manual Control Mode**, then control output is manually entered by the operator.

Process Variable (PV) is shown in Upper Display at the Process Screen.

Lower Display shows the control set point (SV) in Automatic Control Mode and pressing ∇/Δ keys changes the set value. In **Manual Control Mode**, the lower display shows manual output value and in the same way, the operator can adjust this value by pressing ∇/Δ keys. **MN** LED lights in Manual Control Mode.

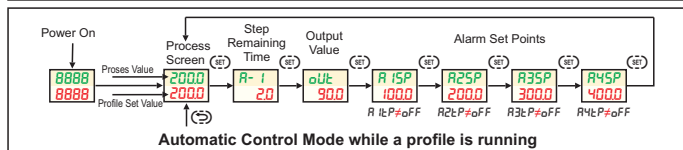
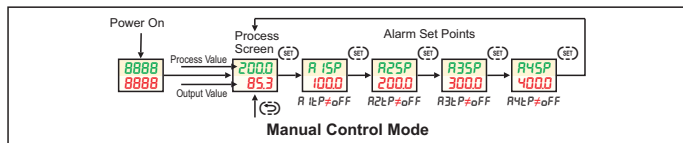
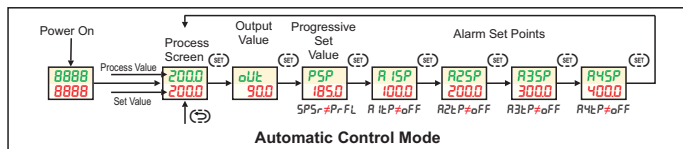

3. FRONT PANEL KEYS AND PROGRAMMING

- 1) Pressing (↵) key returns to the **Process Screen**.
- 2) Pressing (⏪) key accesses to next available screen.
- 3) ▽/▲ keys are used to adjust parameter values.
- 4) In order to reach and adjust a parameter, the operator needs to know in which page the parameter is located. After that, pressing (↵)(⏪) keys together shows **Load** entry screen and ▽/▲ keys are used to enter Security Code. After entering Security Code, pressing (⏪) key shows **PRGE** screen. In this screen, ▽/▲ keys selects the page to be accessed and pressing (⏪) key enters to the selected page. At this stage, consecutive pressing of (⏪) key accesses to next available parameter for adjusting. After reaching to the parameter to be changed, ▽/▲ keys are used to adjust the parameter to required value. While in the pages, pressing (⏪) key more than 2 seconds changes screen to **PRGE** selection screen again.
- 5) Other key functions are explained in relevant parameter explanation in details. Please see parameter explanation sections.
- 6) Some parameters may become invisible depending on other relevant configurations.
- 7) Whole parameter set are depicted in **Figure 3.1**. Depending on the controller model, some parameters may not be exist.

3. FRONT PANEL KEYS AND PROGRAMMING

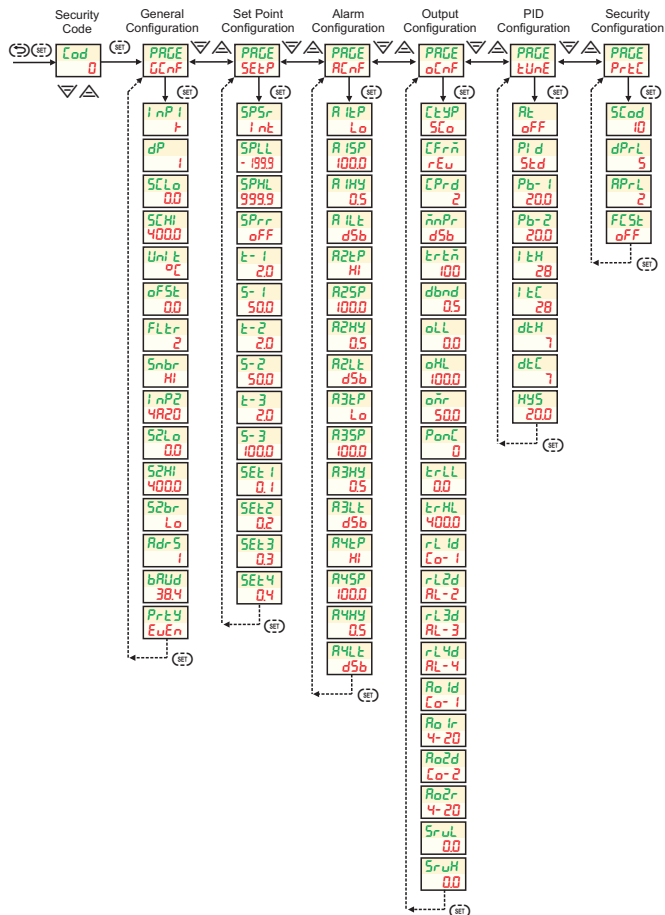

Şekil 3.1. Configuration Pages and Parameters

3.1. Process Screen and Operation Parameters

| Screen | Definition | Min | Max | Unit | Access |
|---------------|----------------|-----|-----|------|--------|
| 200.1 2000 | Process Screen | | | EU | Always |

Process Screen is the power on screen of the controllers and pressing key returns to this screen anytime. In this screen, upper display always shows process value. Lower display shows either control set point or manual output value depending on selected control mode. In automatic mode, control set point can be adjusted between $SP_{LL}..SP_{HL}$ and in manual control mode, the manual output value can be adjusted between $o_{LL}..o_{HL}$ using keys. In manual control mode, MN LED lights.

In Automatic Control Mode, if $SEtP \Rightarrow SP_{Sr}$ (**Control Set Point Source**) = P_{rFL} and the profile is not running, lower display shows P_{rFL} message. After running the profile, depending on the configured profile a changing and non adjustable control set point is followed. Please see $SEtP$ configuration page for detailed profile configuration.

- and : Runs the profile.
- and : Stops the profile.
- : Suspends the profile. Lower display flashes.
- : Rerun the suspended profile.

In Automatic Control Mode, if $SEtP \Rightarrow SP_{Sr}$ (**Control Set Point Source**) = $d_i nP$, lower display shows one of the digital input selectable control set point ($SEt1$, $SEt2$, $SEt3$, $SEt4$) and adjustment is not allowed. Please see $SEtP$ configuration page for detailed usage information.

In order to change control mode, first Process Screen is accessed by pressing key and than key is pressed and hold for at least 3 seconds. Alternatively, Manuel Control Mode can be activated digitally by stimulating 1. digital input if available. If the stimulation is removed, the controller returns to the automatic control mode again. Mode selection is available only if $o_{CNF} \Rightarrow CtYP$ (**Control Type**) is not $nonE$ and $o_{CNF} \Rightarrow nPr$ (**Manuel Mode Selection**) is Enb .

In Manual Control Mode, if $o_{CNF} \Rightarrow CtYP$ (**Control Type**) is bnd (floating valve control), instead of a numeric output percentage, following messages are shown.

- $SEtP$: None of the valve control output is active. Shown when no key is pressed
- o_{Pn} : Valve open output is active. key activates valve open output.
- $CtL5$: Valve close output is active. key activates valve close output.



3.1. Process Screen and Operation Parameters



When an error is detected in process value measurement (Analog Input 1) or measurement value is non displayable, upper display shows one of the following messages.

oPEn : Sensor broken or not connected.

oFL : Input signal is above sensor limits.

uFL : Input signal is below sensor limits.

9999 : Value is bigger than 9999.

uuuu : Value is lower than -1999.

When a lock parameter enabled alarm (**R1Lt**, **R2Lt**, **R3Lt**, **R4Lt**) is detected, (☞) key is pressed in order to release the locked alarm, if the alarm condition is not still exist.

| Screen | Definition | Min | Max | Unit | Access |
|--------------------------|---|-----|-------|--------|-----------------|
| R-x 198 | Remaining Step Time (X = 1, 2, 3) | 0 | 999.9 | minute | Profile running |

Remaining step time and step number is displayed while profile is running (**R- 1**, **R- 2**, **R- 3**).

| | | | | | |
|--------------------------|-------------------------------|------------|------------|---|----------------|
| oUt 650 | Automatic Output Value | oLL | oHL | % | Automatic Mode |
|--------------------------|-------------------------------|------------|------------|---|----------------|

In Automatic Control Mode, controller calculated output value is shown and can not be adjusted. In Heat/Cool control type, negative values indicates cooling.

| | | | | | |
|---------------------------|--------------------------------------|-------------|-------------|--|--------------------|
| PSP 2000 | Progressive Control Set Point | SPLL | SPHL | | SPSr ≠ PrFL |
|---------------------------|--------------------------------------|-------------|-------------|--|--------------------|

In Automatic Control Mode, Progressive Control Set Point is followed. For detail explanation of this parameter, please see **SEtP↔ SPrr (Control Set Point Ramp Rate)**.

| | | | | | |
|----------------------------|---|--------|------|--|-----------------------|
| RxSP 2000 | Alarm Set Points (x = 1, 2, 3, 4) | - 1999 | 9999 | | Alarm Type is not oFF |
|----------------------------|---|--------|------|--|-----------------------|

Alarm set points are followed and adjusted. For the Alarm Configuration, please see (**R1SP**, **R2SP**, **R3SP**, **R4SP**) in **RLnF** Configuration Page.

3.2. Accessing Configuration Pages

In order to access configuration pages, the operator needs to reach security Co d entry screen by pressing (↵) and (⏏) keys together as the first step. Factory settings of Security Code is 10.

| Screen | Definition | Min | Max | Unit | Access |
|-------------|---------------------|-----|------|------|--------|
| Co d 0 | Security Code Entry | 0 | 9999 | | Always |

Security code is entered using ∇ and ▲ keys and (⏏) key is pressed to reach $PRGE$ selection screen. In case of a wrong password entry, only PrL ↔ $dPrL$ (**Parameter Access Level**) and PrL ↔ $PPrL$ (**Parameter Setting Level**) limited access and setting rights become available. In order to get full access and setting rights, the correct code must be entered. In order to reset Security Code, during first 25 seconds after power on, ∇/▲ ve (↵) keys can be pressed together and hold for a second. After that, Security code checking will be disabled at the following try and the operator will be able to enter configuration with full rights in order to reconfigure PrL ↔ $SCod$ (**Security Code**).

| $PRGE$ $GCnF$ | Page Selection Screen | | | | Always |
|------------------|-----------------------|--|--|--|--------|
|------------------|-----------------------|--|--|--|--------|

After selecting the configuration page by pressing ∇ and ▲ keys, pressing (⏏) key enters to the selected page and first parameter of the page appears on the screen. After that consecutive pressing of (⏏) key passes to next parameter. After the last parameter is reached, the screen returns to the Page Selection Screen again. Pressing and holding (⏏) key for 2 seconds also reverts the screen to Page Selection again before reaching the last parameter. ∇ and ▲ keys adjust parameters to required value.

Following pages are available for the configuration.

- (0) $GCnF$: Inputs, scales and MODBUS communication parameters.
- (1) $SEtP$: Control set point options, set limits, profil configuration.
- (2) $REnF$: Alarm configuration.
- (3) $oLrF$: Output configuration, output limits, valve control parameters
- (4) $tUnE$: PID parameters and autotuning
- (5) PrL : Security Code ($SCod$), access and setting rights, factory settings. Pressing (↵) keys returns to the Process Screen.

3.3. General Configuration Page (5LnF)

| Screen | Definition | Min | Max | Unit | Access |
|--------------|-----------------------------------|-----------------|-------------|-------------|--------|
| 5LnF1 | Analog Input 1 Type | | | | Always |
| No | Input Type | Standard | Min. | Max. | |
| (0) | b: Type B Thermocouple | IEC 60584-1 | 60 | 1820 °C | |
| (1) | E: Type E Thermocouple | IEC 60584-1 | -200 | 840 °C | |
| (2) | J: Type J Thermocouple | IEC 60584-1 | -200 | 1120 °C | |
| (3) | K: Type K Thermocouple | IEC 60584-1 | -200 | 1360 °C | |
| (4) | L: Type L Thermocouple | DIN 43710 | -200 | 900 °C | |
| (5) | N: Type N Thermocouple | IEC 60584-1 | -200 | 1300 °C | |
| (6) | R: Type R Thermocouple | IEC 60584-1 | -40 | 1760 °C | |
| (7) | S: Type S Thermocouple | IEC 60584-1 | -40 | 1760 °C | |
| (8) | T: Type T Thermocouple | IEC 60584-1 | -200 | 400 °C | |
| (9) | U: Type U Thermocouple | DIN 43710 | -200 | 600 °C | |
| (10) | Pt: Pt-100 Resistance Thermometer | IEC 60751 | -200 | 840 °C | |
| (11) | 0R20 : 0-20 mA (Linear) | | | | |
| (12) | 4R20 : 4-20 mA (Linear) | | | | |
| (13) | 0U50 : 0-50 mV (Linear) | | | | |
| (14) | 0U1 : 0-1 V (Linear) | | | | |
| (15) | 0U1 : 0.2-1V (Linear) | | | | |

| dP | Decimal Point | 0 | 3 | | Always |
|---|---------------|---|---|--|--------|
| 5LnF1 | | | | | |
| Display format of all parameters with EU unit(Analog Input 1 Unit) . 0 : 0 1 : 0.0 2 : 0.00 3 : 0.000 *If 5LnF1 is thermocouple or resistance thermometer, upper limit for this parameter is 1. | | | | | |

| | | | | | |
|--------------|--|--------|-------|----|---------------------------|
| 5LnF2 | Analog Input 1 Linear Scale Lower Value | -199.9 | 999.9 | EU | Analog Input 1 (mA,mV, V) |
| 5LnF3 | Analog Input 1 Linear Scale Upper Value | -199.9 | 999.9 | EU | Analog Input 1 (mA,mV, V) |

This scale is used to derive process value from the input signal when 5LnF1 (Analog Input 1 Type) is a linear signal such as (mA, mV, V). It is a linear scale and defines how measured value will change over the entire range of input signal. 5LnF2 can be bigger than 5LnF3 .

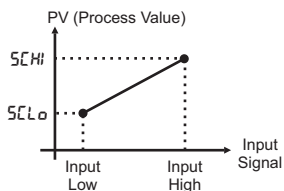

3.3. General Configuration Page (GENF)

| Screen | Definition | Min | Max | Unit | Access |
|------------|------------------|-----|-----|------|--------------------------------------|
| Unit 0E | Temperature Unit | 0E | 0F | | Analog Input 1 Temperature Sensor |

This parameter is monitored when *i nP i* (**Analog Input 1 Type**) is selected as Thermocouple or Resistance Thermometer.

| | | | | | |
|------------|-----------------------------|--------|-------|----|--------|
| oF5t 00 | Analog Input 1 Offset Value | -100.0 | 100.0 | EU | Always |
|------------|-----------------------------|--------|-------|----|--------|

oF5t value is directly added to the process value of Analog Input 1.
Analog Input 1 Process Value = Analog Input 1 Measurement Value + oF5t

| | | | | | |
|-----------|-----------------------|---|----|--------|--------|
| FLtr 2 | Analog Input 1 Filter | 1 | 15 | second | Always |
|-----------|-----------------------|---|----|--------|--------|

It is the moving average time for the Analog Input 1 process value. The measurement refresh time is 500 ms. For example, selecting 5 indicates that the last 10 measurements will be averaged.

| | | | | | |
|------------|---|----|----|--|--------|
| Snbr Hi | Analog Input 1 Sensor Broken Behaviour | Lo | Hi | | Always |
|------------|---|----|----|--|--------|

It determines the measurement value when the Analog Input 1 sensor is detected as broken sensor condition. Sensor break cannot be detected at 0-20 mA inputs. When a broken sensor condition is detected, Analog Input 1 Process Value is adjusted according to the selected value as follows. oPEN message is displayed on the screen.

(0) Lo : Process Value is equal to -32000.

(1) Hi : Process Value is equal to 32000.

| | | | | | |
|---------------|---------------------|------|------|--|---------------------------------|
| i nP2 4-20 | Analog Input 2 Type | 0-20 | 4-20 | | Devices have 2 Analog Inputs |
|---------------|---------------------|------|------|--|---------------------------------|

(0) 0-20 : 0-20 mA

(1) 4-20 : 4-20 mA

3.3. General Configuration Page (GENF)

| Screen | Defintion | Min | Max | Unit | Access |
|------------|--|--------|-------|------|---------------------------------|
| 52Lo 00 | Analog Input 2 Linear Scale Lower Value | -199.9 | 999.9 | EU | Devices have 2 Analog Inputs |

| | | | | | |
|--------------|--|--------|-------|----|---------------------------------|
| 52Hi 4000 | Analog Input 2 Linear Scale Upper Value | -199.9 | 999.9 | EU | Devices have 2 Analog Inputs |
|--------------|--|--------|-------|----|---------------------------------|

This scale is used to derive measurement value from the Analog Input 2 signal. It is a linear scale and defines how measured value will change over the entire range of input signal. 52Lo can be bigger than 52Hi.

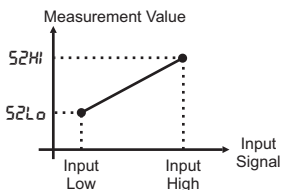

| | | | | | |
|------------|---|----|----|--|--------|
| 52br Lo | Analog Input 2 Sensor Broken Behaviour | Lo | Hi | | Always |
|------------|---|----|----|--|--------|

It determines the measurement value when the Analog Input 2 Sensor detects a broken sensor condition. Sensor break cannot be detected at 0-20 mA inputs. When a broken sensor condition is detected, Analog Input 2 Measurement Value is adjusted according to the selected value as follows.

- (0) Lo : It is equal to 52Lo.
- (1) Hi : It is equal to 52Hi.

| | | | | | |
|-----------|----------------|---|-----|--|--------------------------------------|
| Rdr5 i | Modbus Address | 1 | 127 | | Devices with RS-485 Communication |
|-----------|----------------|---|-----|--|--------------------------------------|

| | | | | | |
|-------------|------------------|--|--|--|--------------------------------------|
| bRld 384 | Modbus Baud Rate | | | | Devices with RS-485 Communication |
|-------------|------------------|--|--|--|--------------------------------------|

- (0) 4.8 kbaud
- (1) 9.6 kbaud
- (2) 19.2 kbaud
- (3) 38.4 kbaud

| | | | | | |
|--------------|---------------|--|--|--|--------------------------------------|
| Prty EuEn | Modbus Parity | | | | Devices with RS-485 Communication |
|--------------|---------------|--|--|--|--------------------------------------|

- (0) nonE : No Parity
- (1) odd : Odd Parity
- (2) EuEn : Even Parity

3.4. Control Set Point Configuration (SEtP)

| Screen | Definition | Min | Max | Unit | Access |
|-------------|---------------------------------|-----|-----|------|--------|
| SPSr int | Control Set Point Source | | | | Always |

- (0) int : Internal. Adjusted using front panel keys
 (1) PrFL : Defined by Profile Parameters
 (2) ErL : Defined by Analog Input 2 measurement
 (3) di nP : Selected by Digital Inputs (Available only in devices with digital inputs.)

| | | | | | |
|---------------|--------------------------------------|--------|------|----|--------|
| SPLL -1999 | Control Set Point Lower Limit | -199.9 | SPHL | EU | Always |
|---------------|--------------------------------------|--------|------|----|--------|

| | | | | | |
|--------------|--------------------------------------|------|-------|----|--------|
| SPHL 9999 | Control Set Point Upper Limit | SPLL | 999.9 | EU | Always |
|--------------|--------------------------------------|------|-------|----|--------|

| | | | | | |
|-------------|---------------------------------------|-----|------|----------------------------|-------------|
| SPrr oFF | Control Set Point Ramping Rate | 0.0 | 60.0 | $\frac{EU}{\text{minute}}$ | SPSr ≠ PrFL |
|-------------|---------------------------------------|-----|------|----------------------------|-------------|

After a change to the control set point, the rate of progression from the current set point to the new set point is determined. This rate specifies the amount of change in the control set point per minute. This behavior of the set point is defined as the Process Set Point (PSP) running in the background. If SEtP → SPrr (**Control Set Point Ramping Rate**) is turned off, this feature is disabled. For example, if this parameter is set to 10.0, and the set point is changed from 100.0 to 200.0, the running set point will reach the newly set point in 10 minutes.

$$(200.0 - 100.0) / 10.0 = 10.0 \text{ minutes}$$

3.4. Control Set Point Configuration (SEtP)

| Screen | Definition | Min | Max | Unit | Access |
|------------|-----------------------------|------|-------|------|-------------|
| 5-x 500 | Step Set Value (X = 1 .. 3) | 5PLL | 5PHL | EU | 5P5r = PrFL |
| t-x 20 | Step Time (X = 1 .. 3) | 0 | 999.9 | min | 5P5r = PrFL |

These are the parameters that needs to be set when the control set point source 5P5r is set to PrFL. For each step, a time ($t-1$, $t-2$, $t-3$) and a corresponding set point ($5-1$, $5-2$, $5-3$) are defined. The profile is created by progressing to the set points at the specified times.

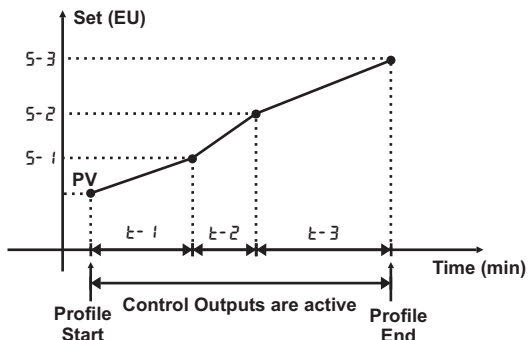

When the profile doesn't work, the control outputs are not active.

If the set point is entered the same as the previous step's set point, the profile continues horizontally. If the step duration is set to *OFF*, the step is canceled, and the process proceeds to the next step.

The operations of Profile Start/Stop and Pause/Resume are performed using the front panel buttons while in the process screen.

- ☞ ve ▲ : Starts Profile.
- ☞ ve ▼ : Stops Profile.
- ▼ : Pauses Profile. The lower display blinks .
- ▲ : Resumes Profile.

Profile operations can also be controlled using digital inputs. When Digital Input 2 is triggered, the profile starts. When the trigger is removed, the profile stops. While the profile is running, if Digital Input 3 is triggered, the profile is paused. When the trigger is removed, the profile resumes.

3.4. Control Set Point Configuration (SEtP)

| Screen | Definition | Min | Max | Unit | Access | | | | | | | | | | | | | | | |
|--|--|--|------------------|------|--------------------------|---------------|-------|------|------|------|---|-----|-----|----|----|---|-----|----|-----|----|
| SEtX Q.1 | Set Values are selected with Digital Inputs (X = 1 .. 4) | SP _{LL} | SP _{HL} | EU | SP _{5r} = di nP | | | | | | | | | | | | | | | |
| <p>Four control set point (SEt 1, SEt2, SEt3, SEt4) selectable with Digital Input 2 and 3 can be adjusted when SP_{5r} is selected as di nP.</p> | | <table border="1"> <thead> <tr> <th>Digital Input</th> <th>SEt 1</th> <th>SEt2</th> <th>SEt3</th> <th>SEt4</th> </tr> </thead> <tbody> <tr> <td>2</td> <td>OFF</td> <td>OFF</td> <td>ON</td> <td>ON</td> </tr> <tr> <td>3</td> <td>OFF</td> <td>ON</td> <td>OFF</td> <td>ON</td> </tr> </tbody> </table> | | | | Digital Input | SEt 1 | SEt2 | SEt3 | SEt4 | 2 | OFF | OFF | ON | ON | 3 | OFF | ON | OFF | ON |
| Digital Input | SEt 1 | SEt2 | SEt3 | SEt4 | | | | | | | | | | | | | | | | |
| 2 | OFF | OFF | ON | ON | | | | | | | | | | | | | | | | |
| 3 | OFF | ON | OFF | ON | | | | | | | | | | | | | | | | |

3.5. Alarm Configuration Page (R_EnF)

Four alarms are defined in the device. Alarm Type, Set Value, Hysteresis and Alarm Lock parameters can be set for each alarms. The alarm signals can be assigned to required relays available on the device.

| Screen | Definition | Min | Max | Unit | Access |
|-------------------------|--|-----|-----|------|--------|
| R _x tP Lo | Alarm Types (x = 1..4) (R ₁ tP, R ₂ tP, R ₃ tP, R ₄ tP) | | | | Always |

(0) oFF : Off

(1) Lo : **Low Alarm** ⇔ If the process value is below the alarm set point, the alarm becomes active. The alarm deactivates when the process value rises above the alarm set point by the amount of hysteresis.

(2) Hi : **High Alarm** ⇔ If the process value is above the alarm set point, the alarm becomes active. The alarm deactivates when the process value drops below the alarm set point by the amount of hysteresis.

(3) Lo d : **Low Deviation** ⇔ It is the same as the **Low Alarm**. The alarm set point is calculated by adding the control set point to the alarm set point (Set = Control Set + Alarm Set).

(4) Hi d : **High Deviation** ⇔ It is the same as the **High Alarm**. The alarm set point is calculated by adding the control set point to the alarm set point (Set = Control Set + Alarm Set).

(5) Lo b : **In Band Alarm** ⇔ The alarm is active when the PV is inside the band

(6) Hi b : **Out Band Alarm** ⇔ The alarm is active when the PV is outside the band



| | | | | | |
|----------------------------|---|------------------|------------------|----|-------------------------|
| R _x SP 100.0 | Alarm Set Points (x = 1..4) (R ₁ SP, R ₂ SP, R ₃ SP, R ₄ SP) | SP _{LL} | SP _{HL} | EU | R _x tP ≠ oFF |
|----------------------------|---|------------------|------------------|----|-------------------------|

| | | | | | |
|--------------------------|---|-----|-------|----|-------------------------|
| R _x HY 0.5 | Alarm Hysteresises (x = 1..4) (R ₁ HY, R ₂ HY, R ₃ HY, R ₄ HY) | 0.0 | 999.9 | EU | R _x tP ≠ oFF |
|--------------------------|---|-----|-------|----|-------------------------|

| | | | | | |
|--------------------------|--|-----|-----|--|-------------------------|
| R _x Lt d5b | Alarm Locks (x = 1..4) (R ₁ Lt, R ₂ Lt, R ₃ Lt, R ₄ Lt) | d5b | Enb | | R _x tP ≠ oFF |
|--------------------------|--|-----|-----|--|-------------------------|

(0) d5b : Alarm lock is not active.

(1) Enb : Alarm lock is active.

If Enb is selected, once an alarm is triggered, it will continue to be active until manually acknowledged using the front panel keys, even if the alarm condition is not exist. To unlock alarms that are in a locked state, you should press the (↵) button while in the process screen. If the alarm is no longer active, pressing this button will release the alarm.

3.5. Alarm Configuration Page (R_LnF)

| R _L nF | EXPLANATION |
|------------------------------------|-----------------------------|
| oFF | Not active when set to oFF. |
| L _o Low Alarm | |
| H _i High Alarm | |
| L _o d Low Deviation | |
| H _i d High Deviation | |
| L _o b In Band Alarm | |
| H _i b Out Band Alarm | |

SP : Control Set Value
 PV : Process Value

3.6. Output Configuration Page (oCnF)

| Screen | Definition | Min | Max | Unit | Access |
|--|---|-----|------|--------|-------------|
| CtYP 5Co | Control Type | | | | Always |
| <p>(0) nonE : Off</p> <p>(1) 5Co : Single Control Output (+) Heat</p> <p>(2) dCo : Double Control Output (+ / -) Heat /Cool</p> <p>(3) bnd : Floating Valve Control</p> <p>(4) PFb : Feedback Controlled Valve Control (Available only in the devices with servo feedback input.)</p> | | | | | |
| EFrn rEu | Control Form | dIr | rEu | | CtYP ≠ nonE |
| <p>It determines control form</p> <p>(0) dIr : If process value is higher than set value, the output increases (Example: Cooling Element).</p> <p>(1) rEu : If process value is higher than set value, the output decreases (Example: Heating Element).</p> | | | | | |
| EPrd 2 | Control Period | 1 | 250 | second | CtYP ≠ nonE |
| <p>It is the refresh time of the PID control output. This parameter also determines the PWM period for PID control done by a relay output.</p> | | | | | |
| nnPr d5b | Manual Mode Selection | d5b | Enb | | CtYP ≠ nonE |
| <p>(0) d5b : The user can not activate the Manual Mode</p> <p>(1) Enb : The user can activate the Manual Mode</p> | | | | | |
| Ertn 100 | Floating Control Valve Travel Time | 10 | 2500 | second | CtYP = bnd |
| <p>The transition time from fully open to fully closed position for the floating valves should be entered in seconds.</p> | | | | | |
| dbnd 0.5 | Dead Band | 0.1 | 25.0 | % | CtYP ≠ nonE |
| <p>When CtYP is set to 5Co or dCo, it determines the minimum value for the output signal. The output is not activated for output values below this threshold.</p> <p>When CtYP is set to PFb or bnd, the valve will not be moved if the difference between the required valve position and the current valve position is less than this value.</p> | | | | | |

3.6. Output Configuration Page (oLrF)

| Screen | Definition | Min. | Max. | Unit | Access |
|-----------|----------------------------|------|------|------|------------|
| oLL 00 | Control Output Lower Limit | 0.0* | oHL | % | LYP ≠ nonE |

* LYP = dLo, the lower value that can be set is -100.0. Negative values indicate cooling.

| | | | | | |
|-------------|----------------------------|-----|-------|---|------------|
| oHL 1000 | Control Output Upper Limit | oLL | 100.0 | % | LYP ≠ nonE |
|-------------|----------------------------|-----|-------|---|------------|

| | | | | | |
|------------|-----------------------------|-----|-----|---|------------|
| oMr 500 | Control Output Manual Reset | oLL | oHL | % | LYP ≠ nonE |
|------------|-----------------------------|-----|-----|---|------------|

When tUnE ⇔ tH (**Integral Time +**) parameter is set to zero (integral is not active), it is added to the output value and determines the output value when the process value is equal to the control setpoint.

| | | | | | |
|-----------|-----------------------|--|--|--|--------|
| PonC 0 | PID Power On Behavior | | | | Always |
|-----------|-----------------------|--|--|--|--------|

(0) It operates with the settings at the moment of power off.

(1) Turns on in automatic mode.

(2) Turns on in automatic mode. Integral Value = 0.

(3) Turns on in manual mode.

(4) Turns on in manual mode. Output Value = 0.

| | | | | | |
|------------|----------------------------------|--------|------|----|--------|
| trLL 00 | Retransmission Scale Lower Value | -199.9 | trHL | EU | Always |
|------------|----------------------------------|--------|------|----|--------|

| | | | | | |
|--------------|----------------------------------|------|-------|----|--------|
| trHL 4000 | Retransmission Scale Upper Value | trLL | 999.9 | EU | Always |
|--------------|----------------------------------|------|-------|----|--------|

The process value and control setpoint can be output as current or voltage via the analog outputs on the device. This process is called Retransmission. trLL and trHL determine the retransmission scale. By setting the parameters RoId and RoZd to Pute, process value retransmission from the related output is activated. Similarly, RoId and RoZd parameters are set to 5Pte and control setpoint retransmission is activated from the related output.

3.6. Output Configuration Page (oLrF)

| Screen | Definition | Min. | Max. | Unit | Access |
|---------------|----------------------------------|------|------|------|--------|
| rLXd [o-1] | Relay Functions (x = 1..4 Relay) | | | | Always |

Parameters that determine the functions of the relays in the device.
(rL1d, rL2d, rL3d, rL4d)

- | | |
|--------------------------------------|--------------------|
| (0) [o-1] : PID + signal (Heating) | (4) RL-1 : Alarm 1 |
| (1) [o-2] : PID - signal (Cooling) | (5) RL-2 : Alarm 2 |
| (2) do-1 : On-Off + signal (Heating) | (6) RL-3 : Alarm 3 |
| (3) do-2 : On-Off - signal (Cooling) | (7) RL-4 : Alarm 4 |

Depending on the device type, some parameters may not be available on the device.

| | | | | | |
|---------------|--|--|--|--|--------|
| RoXd [o-1] | Functions of Analog Outputs (x = 1, 2) | | | | Always |
|---------------|--|--|--|--|--------|

Parameters that determine the function of analog outputs (Ro1d, Ro2d).

- (0) [o-1] : PID + signal (Heating), Conversion Scale: 0 -100 %
- (1) [o-2] : PID - signal (Cooling), Conversion Scale: 0 -100 %
- (2) PULr : Analog Input 1 Retransmission, Conversion Scale: trLL - trHL
- (3) SPTr : Control Set Point Retransmission, Conversion Scale: trLL - trHL

| | | | | | |
|--------------|--------------------------------|--|--|--|--------|
| RoXr 4-20 | Analog Output Types (x = 1, 2) | | | | Always |
|--------------|--------------------------------|--|--|--|--------|

Parameters that determine the output ranges of Analog Outputs (Ro1r, Ro2r).

- | Current Outputs: | Voltage Outputs: |
|--------------------|-------------------|
| (0) 0-20 : 0-20 mA | (0) 0-10 : 0-10 V |
| (1) 20-0 : 20-0 mA | (1) 10-0 : 10-0 V |
| (2) 4-20 : 4-20 mA | (2) 2-10 : 2-10 V |
| (3) 20-4 : 20-4 mA | (3) 10-2 : 10-2 V |

| | | | | | |
|------------|--------------------------------------|--|--|--|------------|
| SrUL 00 | Feedback Valve Fully-Closed Position | | | | [tYP = PFb |
|------------|--------------------------------------|--|--|--|------------|

| | | | | | |
|------------|------------------------------------|--|--|--|------------|
| SrUH 00 | Feedback Valve Fully-Open Position | | | | [tYP = PFb |
|------------|------------------------------------|--|--|--|------------|

SrUL and SrUH are calibration values for fully closed and fully open position of the valve with feedback. While in these menus, the valve is set to fully closed or fully open position depending on the parameter set using the ∇ and \triangle keys and the value is saved by pressing the \odot and ∇ keys. Valve Open output ([o-1]) and Valve Close output ([o-2]) must be directed to the control relays by using rLXd parameters before setting.

3.7. PID Configuration Page (EUNE)

| Screen | Definition | Min. | Max. | Unit | Access |
|-----------|---------------|------|------|------|-------------|
| Rt OFF | PID Auto Tune | OFF | ON | | [EYP ≠ none |

(0) OFF : Cancels the automatic tuning in progress.

(1) ON : Starts automatic tuning.

All PID parameters can be calculated automatically using the Auto PID Tuning feature.

The following steps should be followed for Automatic Tuning.

- 1) Check that all input and output configurations are done correctly.
- 2) The set point value at which the automatic tuning performed must be determined. It is recommended to set this value to the setpoint at which the process will mostly run.
- 3) EUNE \rightarrow PID type should be determined.
- 4) EUNE \rightarrow HYS parameter should be set to a value more than the fluctuation in the process measurement. 0.5 °C is sufficient for most systems. In systems where the process value fluctuates more than this value, the HYS value can be increased.
- 5) If Rt = ON, the automatic PID tuning process starts. To cancel the started process, Rt can be set to OFF. The duration of the tuning process varies depending on the speed of the process. The lower display flashes during the tuning process. At the end of the process, the newly calculated PID parameters are saved and the control process continues with the newly calculated parameters. Rt automatically turns OFF.

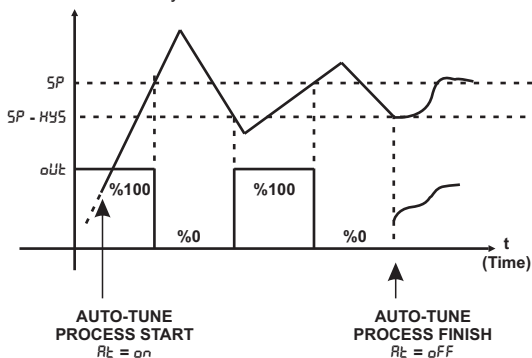

Figure 3.7.1.

3.7. PID Configuration Page (EUnE)

| Screen | Definition | Min. | Max. | Unit | Access |
|-------------|--------------------|------|------|------|-------------|
| Pi d 5td | PID Parameter Type | 5td | Rdu | | CTYP ≠ nonE |

(0) 5td : Standard PID parameters

(1) Rdu : Advanced PID parameters

If selected as Rdu, different values can be used for the integral time and derivative time, depending on the state and level of the process value with respect to the control setpoint.

i tH : Used when the process value is less than the set value.

i tL : Used when the process value is more than the set value.

d tH : Used when the derivative is positive.

d tL : Used when the derivative is negative.

The HYS value is used to switch between integral times. If the process crosses the set value in any direction by HYS value, the integral time parameter is changed.

If 5td is selected, integral and derivative times are automatically equalized by the device (i tL=i tH , d tL=d tH).

| Pb- i 200 | Proportional Band + | 0.1 | 999.9 | EU | CTYP ≠ nonE |
|--------------|---------------------|-----|-------|----|-------------|
|--------------|---------------------|-----|-------|----|-------------|

It is the proportional band value for the PID output in the positive (Heating) direction. Proportional band determines the PID gain and is defined as band in terms of process value.

It is defined as PID Gain = (1 / Proportional Band).

When the process value moves away from the process as much as the proportional band, the output value reaches the minimum or maximum value depending on the direction of movement and the control form. Within the band, it changes proportionally. While a large proportional band decreases the system gain, a small proportional band increases the system gain. The gain shows how the process will react to the deviation from the set point. For example, when the band is defined as 20 °C, the maximum output occurs when the process is 20 °C less than the set point and if the difference is below 20 °C, the output decreases by 5% for each 1 °C approach to the set point (100 / Proportional Band = 5%, Output change per error).

3.7. PID Configuration Page (tUnE)

| Screen | Definition | Min. | Max. | Unit | Access |
|-------------|---------------------|------|-------|------|------------|
| Pb-2 200 | Proportional Band - | 0.1 | 999.9 | EU | LTYP = dLo |

Proportional band for PID output in the negative (cooling) direction.

| | | | | | |
|------------|-----------------|---|------|--------|-------------|
| i tH 28 | Integral Time + | 0 | 9999 | saniye | LTYP ≠ nonE |
|------------|-----------------|---|------|--------|-------------|

Integral time used when the process value is below the setpoint.

| | | | | | |
|------------|-----------------|---|------|--------|------------|
| i tC 28 | Integral Time - | 0 | 9999 | saniye | Pi d = Rdu |
|------------|-----------------|---|------|--------|------------|

Integral time used when the process value is above the setpoint.

| | | | | | |
|-----------|-------------------|---|------|--------|-------------|
| d tH 7 | Derivative Time + | 1 | 2500 | saniye | LTYP ≠ nonE |
|-----------|-------------------|---|------|--------|-------------|

Derivative time for positive process change.

| | | | | | |
|-----------|-------------------|---|------|--------|------------|
| d tC 7 | Derivative Time - | 1 | 2500 | saniye | Pi d = Rdu |
|-----------|-------------------|---|------|--------|------------|

Derivative time for negative process change.

| | | | | | |
|------------|------------|-----|-------|----|-------------|
| HYS 200 | Hysteresis | 0.0 | 999.9 | EU | LTYP ≠ nonE |
|------------|------------|-----|-------|----|-------------|

The HYS parameter is used as hysteresis in the 3 operations listed below.

- 1) ON-OFF control hysteresis
- 2) Automatic PID tuning test hysteresis (see Figure 3.7.1.)
- 3) When PID parameter Rdu is selected, i tH or i tC integral time is used depending on whether the process value is above or below the setpoint. To switch between integral times, the process must cross the setpoint by amount of the HYS parameter.

3.8. Security Configuration Page (PrL)

| Screen | Definition | Min. | Max. | Unit | Access |
|------------|---------------|------|------|------|--------|
| 5C0d 10 | Security Code | 0 | 9999 | | Always |

This is the security code that is asked when accessing the configuration pages.

| dPrL 5 | Parameter Access Level | 0 | 9 | | Always |
|-----------|------------------------|---|---|--|--------|
|-----------|------------------------|---|---|--|--------|

Determines the pages that can be monitored in case the security code is entered incorrectly when accessing the configuration pages. 10 monitoring authorizations are defined. Each authorization includes the authorizations that come before it. For example, if 6 is selected, 5EŁP, ĆĆnF, Operation Parameters, Set Value and Process Value can be monitored.

- 0 : Process Value
- 1 : Set Value
- 2 : Operation Parameters (R 15P, R25P, vb.)
- 3 : Reserved
- 4 : Reserved
- 5 : ĆĆnF Page
- 6 : 5EŁP Page
- 7 : RĆnF Page
- 8 : oĆnF Page
- 9 : ŁŪnE Page

| RPŁ 2 | Parameter Setting Level | 0 | 9 | | Always |
|----------|-------------------------|---|---|--|--------|
|----------|-------------------------|---|---|--|--------|

Determines the pages that can be set if the security code is entered incorrectly when accessing the configuration pages. 10 setting authorizations are defined. Each authorization includes the authorizations that come before it. For example, if 6 is selected, 5EŁP, ĆĆnF, Operation Parameters and Set Value can be set.

- 0 : No authorization
- 1 : Set Value
- 2 : Operation Parameters (R 15P, R25P, vb.)
- 3 : Reserved
- 4 : Reserved
- 5 : ĆĆnF Page
- 6 : 5EŁP Page
- 7 : RĆnF Page
- 8 : oĆnF Page
- 9 : ŁŪnE Page

3.8. Security Configuration Page (PrEt)

| Screen | Definition | Min. | Max. | Unit | Access |
|-------------|------------------|------|------|------|--------|
| FCSE oFF | Factory Settings | | | | Always |

- (0) oFF : It does not perform any operation.
 (1) LoRd : Loads the settings previously backed up with SRuE operation.
 (2) SRuE : Backs up the device settings.
 (3) dFLt : Loads the factory settings to the device.

To perform the selected operation, press the ∇ button while the \odot button is pressed.

These operations may cause all settings of your device to change .

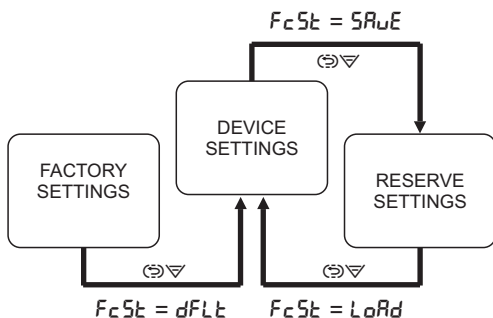

4. CONFIGURATION STEPS AND APPLICATIONS

The recommended configuration sequence is given below. It is not obligatory to perform the configuration in the order described. Detailed descriptions of all parameters described can be found on the relevant configuration pages.

1) Device configuration should be started from the General Configuration page (ГЦНФ). **Analog Input 1**, **Analog Input 2** and **Communication** parameters can be set on this page. The first parameter to be set before setting other parameters in the device is **Decimal Display Format** (dP).

Since many parameters in the device are based on dP , changing dP requires many parameters to be readjusted.

For Analog Input 1, **Input Type** ($i nP 1$), **measurement scale** ($5CLo$, $5CHi$) if a linear (mA, mV, V) input is selected, **Temperature Unit** ($Uni t$) if a temperature sensor is selected, $oF5t$ parameter if an **offset** will be added to the measurement value, **filter** parameter $FLEr$ and **Sensor Broken Behavior** $5nbr$ parameters must be set.

If the device has 2nd Analog input and **the control set point is to be input externally with mA signal**, Analog Input 2 settings must be made. For Analog Input 2, **Input Type** ($i nP 2$), **measurement scale** ($52Lo$, $52Hi$) and **Sensor Broken Behavior** ($52br$) parameters must be set.

If **Modbus communication** will be used, **Modbus Communication Address** ($Rdr5$), **Communication Rate** ($bRid$) and **Parity Bit** ($Prty$) parameters must be set.

2) All parameters related to the **Control Set Point** can be accessed from the $5EtP$ page. According to the selection determined with the $5P5r$ parameter, the control set point can be entered to the device with 4 different methods. If the control set point is to be set with the keys on the front panel, $5P5r = i n t$, if it is to be given externally with the 2nd Analog Input, $5P5r = Er t$, if it is to be given as a profile, $5P5r = Pr FL$, if it is to be selected with digital inputs, $5P5r = di nP$ should be selected. Limits of the control set point ($5PLL$, $5PHL$), progress speed of the control set point $5Prr$ (not monitored when $5P5r = Pr FL$) must be set. If $5P5r = di nP$ is selected, 4 set points ($5Et 1$, $5Et 2$, $5Et 3$ and $5Et 4$) must be adjusted. If $5P5r = Pr FL$ is selected, step parameters ($5- 1$, $5- 2$, $5- 3$, $t- 1$, $t- 2$, $t- 3$) must be set for the profile.

4. CONFIGURATION STEPS AND APPLICATIONS

3) The device has 4 alarms that can be used for different purposes. For each alarm, the alarm type parameters ($R1tP$, $R2tP$, $R3tP$, and $R4tP$) can be configured according to the desired alarm type, and the relevant set point ($R1SP$, $R2SP$, $R3SP$, and $R4SP$), hysteresis ($R1HY$, $R2HY$, $R3HY$, and $R4HY$), and lock ($R1Lt$, $R2Lt$, $R3Lt$, and $R4Lt$) parameters can be adjusted. The relay outputs from which the alarms will be output can be configured using the $rL1d$, $rL2d$, $rL3d$ and $rL4d$ parameters on the $oLnF$ page.

4) All configuration related to outputs is done in the $oLnF$ page. The device has 4 different control types.

The control type is selected using the $EtYP$ parameter. If $EtYP=nonE$ is selected, no control will be performed. For all control types, the lower and upper limits of the control output (oLL , oHL), Manual Reset ($o\tilde{r}$) if PID integral is not used, control mode ($EFr\tilde{n}$), control period ($EPrd$), and dead band ($dbnd$) parameters must be adjusted.

In applications where a transition from Automatic mode to Manual mode is required during control, Manual Mode Selection parameter should be set as $\tilde{n}Pr = Enb$.

Usage as a Single-Output PID Control Device

The control type should be set to $EtYP=5Lo$. In this control type, the output signal is calculated only as a positive value ($Lo-1$) within the range of (%0.0 to %100). This variable can be transferred to the desired output using the $rLxd$ relay control parameters or the $Roxd$ analog output control parameters.

Usage as a Dual-Output PID Control Device (HEAT/COOL)

The control type should be selected as $EtYP = dLo$. In this control type, the output signal is calculated within the range of -100% to +100%. Positive values are assigned to the $Lo-1$ control variable (Heat), while negative values are assigned to the $Lo-2$ control variable (Cool). These variables can be assigned to the $rLxd$ relay control parameters or $Roxd$ analog output control parameters, allowing for heating and cooling outputs to be obtained from the desired relays or analog outputs.

Open-Loop Valve Control (Floating Control)

The control type should be selected as $\text{CtrlYP} = \text{bnd}$. In this control type, the valve is controlled using Open and Close signals without feedback. The Open signal is assigned to the Ctrl-1 control variable, while the Close signal is assigned to the Ctrl-2 control variable. These variables can be assigned to the $rLxd$ relay control parameters, allowing the Valve Open and Valve Close signals to be obtained from the desired relays. The valve travel time trtn should be set.

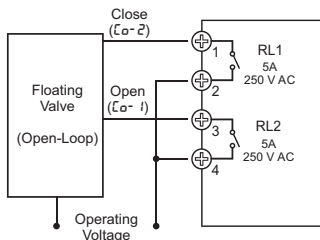

Feedback Valve Control (Feedback in Servo System)

The control type should be selected as $\text{CtrlYP} = \text{Pfb}$. In this control type, the valve position is controlled using Open and Close signals based on the value read from the feedback input of the valve. The Open signal is assigned to the Ctrl-1 control variable, while the Close signal is assigned to the Ctrl-2 control variable. These variables can be assigned to the $rLxd$ relay control parameters, allowing the Valve Open and Valve Close signals to be obtained from the desired relays. After the assignment of control signals is completed, the feedback input should be calibrated using the $5rUL$ and $5rUH$ parameters.

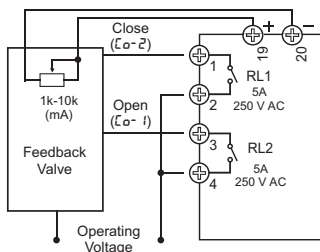

5) PID control parameters are adjusted from the tUnE page. PID parameters $Pb1$, $Pb2$, iEh , iEL , dEH , and dEL can be adjusted manually, or the Auto-Tune parameter $Rt=on$ can be selected to calculate them automatically. Before starting to adjust the PID parameters, the PID type and control set point should be selected.

6) The value of the Security Code ($5Cod$), parameter access and setting levels ($dPrL$, $RPrL$), and factory setting options ($F5t$) can be set from the Security Configuration ($PrtE$) page.

5. MODBUS COMMUNICATION

Devices with communication feature operate as Modbus RTU Slaves. The supported functions are listed below. All data, except for the status bits, is in signed, word (2-byte) and big-endian format.

03 : Read Holding Registers

05 : Write Single Coil

06 : Write Single Register

16 : Write Multiple Register

Adr 5 (**Modbus Address**), *baud* (**Modbus Baud Rate**) and *Prty* (**Modbus Parity**) settings are explained in the *GEN* page. The data consists of 8-bit data and 1 stop bit. Up to 127 devices can be connected in parallel on the same communication line. Each device should have a different Modbus Address, while the Modbus Baud Rate and Modbus Parity settings should be the same.

R : Read-only

W : Write-only

R/W : Read and Write

Status Bits 1

Starting from the least significant bit (0th bit is the least significant):

- (00) Relay 1 Energized
- (01) Relay 2 Energized
- (02) Relay 3 Energized
- (03) Relay 4 Energized
- (04) Analog Input 1 Sensor Broken
- (05) Analog Input 1 Above Limits
- (06) Analog Input 1 Below Limits
- (07) Manual Control Active
- (08) Valve Open Signal Active
- (09) Valve Close Signal Active
- (10) Profile Running
- (11) Profile On Hold
- (12) Auto-Tuning in Progress
- (13) Reserved
- (14) Reserved
- (15) Reserved

Status Bits 2

Starting from the least significant bit (0th bit is the least significant):

- (00) Digital Input 1 Triggered
- (01) Digital Input 2 Triggered
- (02) Digital Input 3 Triggered
- (03) Reserved
- (04) Alarm 1
- (05) Alarm 2
- (06) Alarm 3
- (07) Alarm 4
- (08) Reserved
- (09) Reserved
- (10) Reserved
- (11) Reserved
- (12) Reserved
- (13) Reserved
- (14) Reserved
- (15) Reserved

5. MODBUS COMMUNICATION

Register Address Table

| Address | Access | Parameter | Explanation | Min. | Max. |
|---------|--------|-------------|--------------------------|-------|------|
| 0 | R | | Status Bits 1 | | |
| 1 | R | | Status Bits 2 | | |
| 2 | R | | Process Value | | |
| 3 | R | <i>P5P</i> | Progressive Set Point | | |
| 4 | R | | Reserved | | |
| 5 | R | | Reserved | | |
| 6 | R | | Reserved | | |
| 7 | R | | Remaining Step Time | | |
| 8 | R | <i>dP</i> | Decimal Point | | |
| 9 | R | <i>SP5r</i> | Control Set Point Source | | |
| 10 | R | <i>CTYP</i> | Control Type | | |
| 11 | R/W | <i>OUT</i> | Output Value | -1000 | 1000 |
| 12 | R/W | | Control Set Point | -1999 | 9999 |
| 13 | R/W | <i>At</i> | PID Auto Tune | 0 | 1 |
| 14 | R/W | | Reserved | | |
| 15 | R/W | | Reserved | | |
| 16 | R/W | | Reserved | | |
| 17 | R/W | | Reserved | | |
| 18 | R/W | | Reserved | | |
| 19 | R/W | | Reserved | | |
| 20 | R/W | | Reserved | | |
| 21 | R/W | | Reserved | | |
| 22 | R/W | | Reserved | | |
| 23 | R/W | | Reserved | | |
| 24 | R/W | | Reserved | | |
| 25 | R/W | | Reserved | | |
| 26 | R/W | | Reserved | | |
| 27 | R/W | | Reserved | | |
| 28 | R/W | | Reserved | | |
| 29 | R/W | | Reserved | | |
| 30 | R/W | | Reserved | | |
| 31 | R/W | | Reserved | | |
| 32 | R/W | | Reserved | | |
| 33 | R/W | | Reserved | | |
| 34 | R/W | | Reserved | | |
| 35 | R/W | | Reserved | | |
| 36 | R/W | <i>Pb-1</i> | Proportional Band + | 1 | 9999 |
| 37 | R/W | <i>Pb-2</i> | Proportional Band - | 1 | 9999 |
| 38 | R/W | <i>I tH</i> | Integral Time + | 0 | 9999 |
| 39 | R/W | <i>d tH</i> | Derivative Time + | 0 | 2500 |

5. MODBUS COMMUNICATION

Register Address Table

| Address | Access | Parameter | Explanation | Min. | Max. |
|---------|--------|-----------|---|-------|------|
| 40 | R/W | HYS | Hysteresis | 0 | 9999 |
| 41 | R/W | SP5r | Control Set Point Source | 0 | 3 |
| 42 | R/W | SPLL | Control Set Point Lower Limit | -1999 | 9999 |
| 43 | R/W | SPHL | Control Set Point Upper Limit | -1999 | 9999 |
| 44 | R/W | SPrr | Control Set Point Ramping Rate | 0 | 600 |
| 45 | R/W | SEt1 | Set Point-1 (selected with digital inputs) | -1999 | 9999 |
| 46 | R/W | SEt2 | Set Point-1 (selected with digital inputs) | -1999 | 9999 |
| 47 | R/W | SEt3 | Set Point-1 (selected with digital inputs) | -1999 | 9999 |
| 48 | R/W | SEt4 | Set Point-1 (selected with digital inputs) | -1999 | 9999 |
| 49 | R/W | | Reserved | | |
| 50 | R/W | R1tP | Alarm 1 Type | 0 | 6 |
| 51 | R/W | R1HY | Alarm 1 Hysteresis | 0 | 9999 |
| 52 | R/W | R1Lk | Alarm 1 Lock | 0 | 1 |
| 53 | R/W | R1SP | Alarm 1 Set | -1999 | 9999 |
| 54 | R/W | R2tP | Alarm 2 Type | 0 | 6 |
| 55 | R/W | R2HY | Alarm 2 Hysteresis | 0 | 9999 |
| 56 | R/W | R2Lk | Alarm 2 Lock | 0 | 1 |
| 57 | R/W | R2SP | Alarm 2 Set | -1999 | 9999 |
| 58 | R/W | R3tP | Alarm 3 Type | 0 | 6 |
| 59 | R/W | R3HY | Alarm 3 Hysteresis | 0 | 9999 |
| 60 | R/W | R3Lk | Alarm 3 Lock | 0 | 1 |
| 61 | R/W | R3SP | Alarm 3 Set | -1999 | 9999 |
| 62 | R/W | R4tP | Alarm 4 Type | 0 | 6 |
| 63 | R/W | R4HY | Alarm 4 Hysteresis | 0 | 9999 |
| 64 | R/W | R4Lk | Alarm 4 Lock | 0 | 1 |
| 65 | R/W | R4SP | Alarm 4 Set | -1999 | 9999 |
| 66 | R/W | CTYP | Control Type | 0 | 4 |
| 67 | R/W | CFrn | Control Form | 0 | 1 |
| 68 | R/W | CPrd | Control Period | 1 | 250 |
| 69 | R/W | nnPr | Manual Mode Selection | 0 | 1 |
| 70 | R/W | trtn | Floating Control Valve Travel Time | 10 | 2500 |
| 71 | R/W | dbnd | Dead Band | 1 | 250 |
| 72 | R/W | oLL | Single Side Control Output Lower Limit (CTYP=5nGL) | 0 | 1000 |
| 73 | R/W | oHL | Single Side Control Output Upper Limit (CTYP=5nGL) | 0 | 1000 |
| 74 | R/W | onr | Single Side Control Output Manual Reset (CTYP=5nGL) | 0 | 1000 |
| 75 | R/W | oLL | Double Side Control Output Lower Limit (CTYP=dbL) | -1000 | 1000 |
| 76 | R/W | oHL | Double Side Control Output Upper Limit (CTYP=dbL) | -1000 | 1000 |
| 77 | R/W | onr | Double Side Control Output Manual Reset (CTYP=dbL) | -1000 | 1000 |
| 78 | R/W | PaonC | PID Power On Behaviour | 0 | 4 |
| 79 | R/W | rLld | Relay 1 Function | 0 | 14 |

5. MODBUS COMMUNICATION

Register Address Table

| Address | Access | Parameter | Explanation | Min. | Max. |
|---------|--------|-----------|---|-------|------|
| 80 | R/W | rL2d | Relay 2 Function | 0 | 14 |
| 81 | R/W | rL3d | Relay 3 Function | 0 | 14 |
| 82 | R/W | rL4d | Relay 4 Function | 0 | 14 |
| 83 | R/W | Ro1d | Analog Output 1 Function | 0 | 3 |
| 84 | R/W | Ro2d | Analog Output 2 Function | 0 | 3 |
| 85 | R/W | Ro1r | Analog Output 1 Type | 0 | 3 |
| 86 | R/W | Ro2r | Analog Output 2 Type | 0 | 3 |
| 87 | R/W | i nP1 | Analog Input 1 Type | 0 | 15 |
| 88 | R/W | i nP2 | Analog Input 2 Type | 0 | 1 |
| 89 | R/W | dP | Decimal Point | 0 | 3 |
| 90 | R/W | 5LLo | Analog Input 1 Linear Scale Lower Value | -1999 | 9999 |
| 91 | R/W | 5LHi | Analog Input 1 Linear Scale Upper Value | -1999 | 9999 |
| 92 | R/W | 5rLL | Retransmission Scale Lower Value | -1999 | 9999 |
| 93 | R/W | 5rHL | Retransmission Scale Upper Value | -1999 | 9999 |
| 94 | R/W | Un1t | Analog Input 1 Temperature Unit | 0 | 1 |
| 95 | R/W | oF5t | Analog Input 1 Offset Value | -1000 | 1000 |
| 96 | R/W | FLtF | Analog Input 1 Filter | 1 | 15 |
| 97 | R/W | 5nbr | Analog Input 1 Sensor Broken Behaviour | 0 | 1 |
| 98 | R/W | | Reserved | | |
| 99 | R/W | | Reserved | | |
| 100 | R/W | | Reserved | | |
| 101 | R/W | Rdr5 | Modbus Address | 1 | 127 |
| 102 | R/W | bRud | Modbus Baud Rate | 0 | 3 |
| 103 | R/W | Prty | Modbus Parity | 0 | 2 |
| 104 | R/W | i tE | Integral Time - | 0 | 9999 |
| 105 | R/W | dtE | Derivative Time - | 0 | 2500 |
| 106 | R | uEr | Software Version | | |
| 107 | R/W | 52Lo | Analog Input 2 Linear Scale Lower Value | -1999 | 9999 |
| 108 | R/W | 52Hi | Analog Input 2 Linear Scale Upper Value | -1999 | 9999 |
| 109 | R/W | 52br | Analog Input 2 Sensor Broken Behaviour | 0 | 1 |
| 110 | R/W | Pi d | PID Parameter Type | 1 | |
| 111 | R/W | | Reserved | | |
| 112 | R/W | | Reserved | | |
| 200 | R/W | 5-1 | 1. Step Set Value | -1999 | 9999 |
| 201 | R/W | t-1 | 1. Step Time | 0 | 9999 |
| 202 | R/W | | Reserved | | |
| 203 | R/W | | Reserved | | |
| 204 | R/W | 5-2 | 2. Step Set Value | -1999 | 9999 |
| 205 | R/W | t-2 | 2. Step Time | 0 | 9999 |
| 206 | R/W | | Reserved | | |

5. MODBUS COMMUNICATION

Register Address Table

| Address | Access | Parameter | Explanation | Min. | Max. |
|---------|--------|-----------|-------------------|-------|------|
| 207 | R/W | | Reserved | | |
| 208 | R/W | 5-3 | 3. Step Set Value | -1999 | 9999 |
| 209 | R/W | 4-3 | 3. Step Time | 0 | 9999 |
| 210 | R/W | | Reserved | | |
| 211 | R/W | | Reserved | | |

Coil Address Table

| Address | Access | Parameter | Explanation | 0 (Reset) | 1 (Set) |
|---------|--------|-----------|-----------------------|-----------|---------|
| 0 | W | | Manual/Auto Mod | Auto | Manual |
| 1 | W | | Valve Open | | Open |
| 2 | W | | Valve Close | | Close |
| 3 | W | | Profile Start/Finish | Finish | Start |
| 4 | W | | Profil Bekle/Devam | Resume | Pause |
| 5 | W | | Kilitli Alarmları Sil | | Delete |

The coil addresses for Valve Open and Valve Close can be used to control the valve via communication when $\text{CLYP} = \text{bnd}$ and in manual mode.