

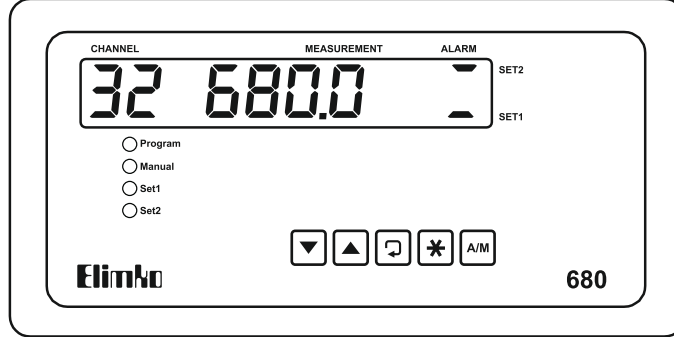

## E-680 Series Universal Data Loggers / Scanners



### Manufacturer / Technical Support

Elimko Elektronik İmalat ve Kontrol Ltd. Şti.  
8. Cadde 21. Sokak No:16 Emek 06510 Ankara / TÜRKİYE  
Telefon: + 90 312 212 64 50 Faks: + 90 312 212 41 43  
www.elimko.com.tr • e-mail:elimko@elimko.com.tr

## User Manual



E-680

E-680 scanners / data loggers are designed for panel mounting and should be used in an industrial environment.

- The package of E-680 device contains;
  - Device
  - 2 pieces of mounting clamps
  - User manual
  - Guarantee certificate
- After opening the package, please check the contents with the above list. If the delivered product is wrong type, any item is missing or there are visible defects, contact the vendor from which you purchased the product.
- Before installing and operating the device, please read the user manual thoroughly.
- The installation and configuration of the controller must only be performed by a person qualified in instrumentation.
- Keep the unit away from flammable gases, that could cause explosion.
- Do not use alcohol or other solvents to clean the device. Use a clean cloth soaked in water tightly squeezed to gently wipe the outer surface of the device.
- It is not used in medical applications.



### EU DIRECTIVE COMPLIANCE

Low Voltage Directive  
EN 61010-1  
EMC Directive  
EN 61326-1

KY-680-1123-0

**Index**

1. Introduction..... 2-3

1.1. Technical Specifications..... 4-5

1.2. Type Coding..... 6

1.3. Dimensions..... 7

1.4. Panel Mounting..... 8

2. Usage..... 9

2.1. General..... 9-12

2.2. Configuration Pages..... 13

2.2.1. General Configuration Page..... 14-16

2.2.2. Alarm Configuration Page..... 17-19

2.2.3. Input Configuration Page..... 20-25

2.2.4. Security Configuration Page..... 26

2.2.5. Calibration Page..... 27-30

2.3. Warning Messages..... 31

2.4. E-680 Connection Diagrams..... 32-35

2.5. E-680 Jumper Settings..... 36-37

2.6. E-680 Communication Connection..... 38

**1. Introduction**

E-680 series universal data loggers / scanners are advanced new generation microcontroller based industrial instruments, dimensions of 96×192 mm compatible with IEC/TR 60668 standards. Universal inputs and outputs of the device can be programmed easily by the user. E-680 series indicate measurements from 32 different points on instrument display and determines alarm conditions according to the result of comparison of two set points for each channel. The alarm conditions can be directed to the common alarm relays and / or to the independent relays. The instruments can be connected to an RS-485 communication line and the data can be collected and stored in a centrally located PC.

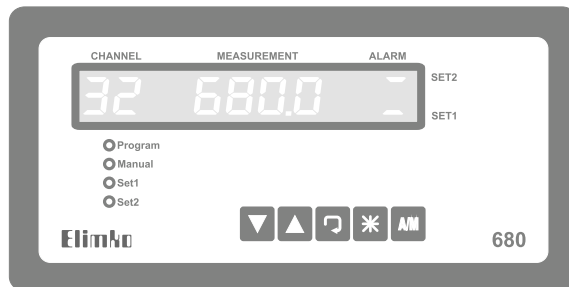

**Figure 1.1. E-680 front view**

(continue on next page)

## 1. Introduction

- High reading sensitivity with 16 bit resolution
- Infinite life time and high isolation voltage semiconductor multiplexer relay
- Standart RS-485 Modbus communication interface
- 2 common alarm relays and 16 independent alarm relay output
- Up to 2 configurable analog outputs for retransmission output
- Each channel can be programmed independently
- 2 set points for each input
- Possibility of defining alarm types for each set point
- Possibility of defining hysteresis for each set point
- Directing alarm states to a common or independent relay
- Programmable display and scan intervals
- Flow rate calculation with compensation up to 10 channels
- Arithmetic operations (add, subtract, multiply or divide with a constant ) on physical channels
- Possibility of connecting up to 31 instruments to a PC by the same communication line
- Distributed system structure

### 1.1. Technical Specification

|                                 |   |
|---------------------------------|---|
| <b>Input Types</b>              | <b>Thermocouple:</b> B, E, J, K, L, N, R, S, T, U <b>Resistance Thermometer:</b> Pt-100, CUST<br><b>Voltage:</b> 0-50 mV, 0-1 V, 0.2-1 V, 0-10 V (Linear) <b>Current:</b> 0-20 mA, 4-20 mA (Linear)   |
| <b>Alarm Outputs</b>            | SPST-NO 250 V AC 3A relay   |
| <b>Display Resolution</b>       | 1/9999  |
| <b>Display Type</b>             | 9 digit, 14mm 7 segment led display   |
| <b>Accuracy</b>                 | <b>Thermocouple:</b> ( $\pm 0.5$ or $\pm 1^\circ\text{C}$ of indicated value) $\pm 1$ digit max.<br><b>Pt-100:</b> ( $\pm 0.5$ or $\pm 1^\circ\text{C}$ of indicated value) $\pm 1$ digit max.<br><b>Voltage/Current:</b> $\pm 0.5$ FS $\pm 1$ digit max. |
| <b>Analog Digital Converter</b> | 16 bit  |
| <b>Digital Analog Converter</b> | 12 bit  |
| <b>Input Scan Time</b>          | 0.2-9.9 sec.  |
| <b>Display Scan Time</b>        | 1-99 sec.   |
| <b>Noise Suppression</b>        | 120 dB at 50 Hz   |

**1.1. Technical Specification**

|                                     |  |
|-------------------------------------|--|
| <b>Operating Temperature</b>        | -10°C, +55°C (14°F, 131°F) (With no condensation or icing)                                       |
| <b>Storage Temperature</b>          | -25°C, +65°C (-13°F, +149°F) (With no condensation or icing)                                     |
| <b>T/C Temperature Compansation</b> | 0°C-50°C   |
| <b>Power Supply</b>                 | 85-265 V <sub>AC</sub> / 85-375 V <sub>DC</sub><br>20-60 V <sub>AC</sub> / 20-85 V <sub>DC</sub> |
| <b>Power Consumption</b>            | 4 W (7 VA)   |
| <b>Protection Class</b>             | IP 66 Front Panel (NEMA 4X)<br>IP 20 Rear Case   |
| <b>Contact Capacity</b>             | NA Contact 250 V <sub>AC</sub> 3 A   |
| <b>Relay Mechanical Life</b>        | 10.000.000 operation*  |
| <b>Relay Electrical Life</b>        | >1.000.000 operation (1/10 load)   |
| <b>Memory</b>                       | EEPROM max. 10 <sup>5</sup> writing  |
| <b>Weight</b>                       | 650 g  |

\* The relay life differs according to the usage configuration. When the relays are old, their contacts could melt or burn out.

**1.2. Type Coding**

E – 680 – UU – V – W – XX – Y – Z

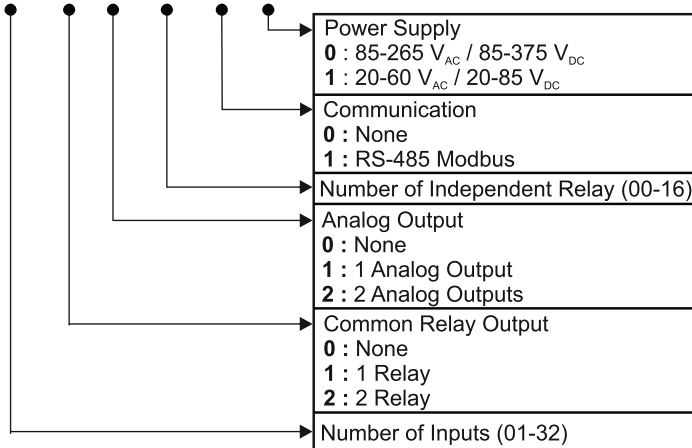

**Coding Example:**

- E-680-16-2-0-08-1-0
- 16 input, 2 common relay
- 8 independent relay output
- RS-485 communication
- 85-265 V<sub>AC</sub> / 85-375 V<sub>DC</sub> supply

**Note:** XX must be coded as '0' for devices having more than 16 channels.

### 1.3. Dimensions

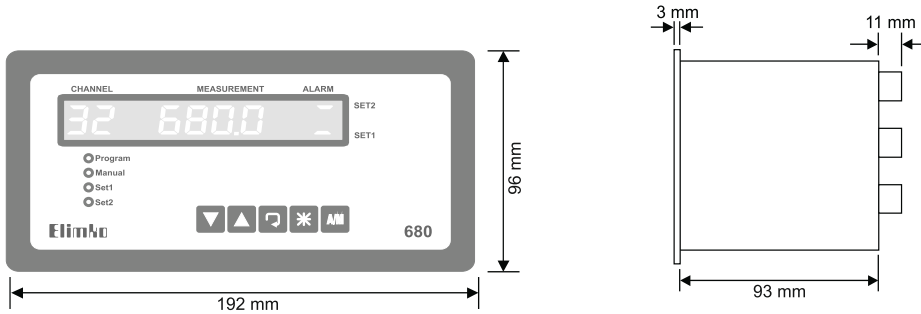

**Note:** Drawings are not in real scale. Do not use for scaling.

### 1.4 Panel Mounting

- E-680 controller should be installed inside a suitable grounded metal enclosure (panel). This must prevent the live parts being accessible to human hands and metal tools.
- E-680 controller does not include a power switch. Therefore, the power supply of the controller and power outputs must be wired through the proper fuse or circuit breaker.
- To minimize the pick-up of electrical noise, the wiring of low voltage lines, particularly the sensor inputs should be routed away from the high-current power cables. If this is not possible use screened cables and apply grounding.
- The cables used for powering the controller and the power outputs must conform to the standards IEC 60245 and IEC 60227.

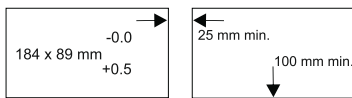

**Figure 1.2.**  
Panel Cutout and  
Minimum Spacing



- Cut a hole in the panel. (See the figure for overall dimensions.)
- Slide the controller into the cutout from the front of the panel.
- There are three clamp holes located at the top and the bottom side of the device. Use the convenient ones and fit the mounting clamps to the controller ensuring the lugs are located in their slots.
- Fasten the mounting clamps using the retaining screws.

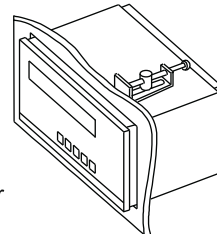

## 2. Usage

### 2.1 General

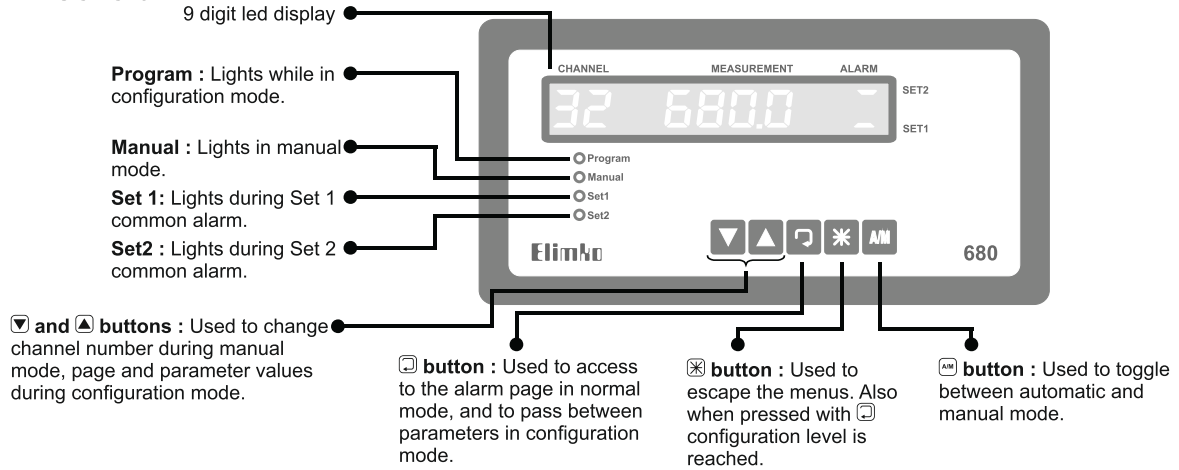

### 2.1 General

The front panel is formed by 9 digit 7 segment led display, **Program**, **Manual**, **Set 1**, **Set 2** leds and ▼, ▲, □, \*, AM button which are used for programming and manual controls. **Program** led lights when entered to the configuration mode, and **Manual** led lights during Manual mode, **Set 1** led lights during SET 1 common alarm and **Set 2** led lights during SET 2 common alarm period. During normal mode, channel numbers are displayed in the first two digits, measured values in the digits 4-7 and alarm information in the last digit of the 9 digit LED display. Channel information can be watched automatically or manually. In automatic mode, channel information can be monitored consecutively. The display time of a channel data is equal to *CR* parameter in seconds. AM button is used for switching from automatic to manual or manual to automatic mode. In manual mode only one channel can be monitored, channel number is selected by ▼ and ▲ buttons.



Figure 2.1. Operator Page

2.1 General

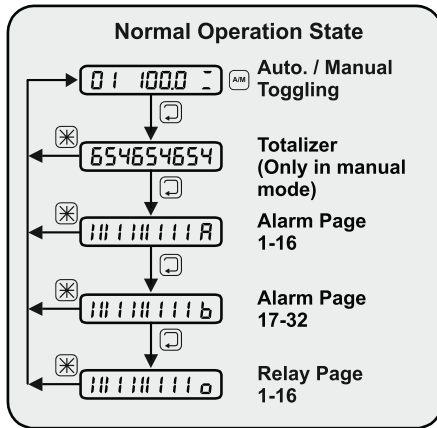

When the device is in normal operation state, the button can be used to switch to the totalizer and the alarm pages. When the device is in manual mode and the button is pressed, totalizer value is displayed. In this page, simultaneously pressing and buttons reset totalizer. Next to the totalizer page, alarm pages are reached. All alarms (Set 1, Set 2) can be seen together in these pages. In the first alarm page, alarms of the channels 1 to 16 are displayed and letter *A* is shown in the last digit. In the second alarm page, alarms of channels 17 to 32 are displayed and letter *B* is shown in the last digit. In the third alarm page, status of the output relays R1 to R16 are displayed and letter *O* is shown in the last digit. **Figure 2.2.** shows the display format of the alarm pages. While in the totalizer or alarm pages pressing the button reverts to the normal operation page. Alarm status of the channel which are not active or closed for scanning are shown as empty.

2.1 General

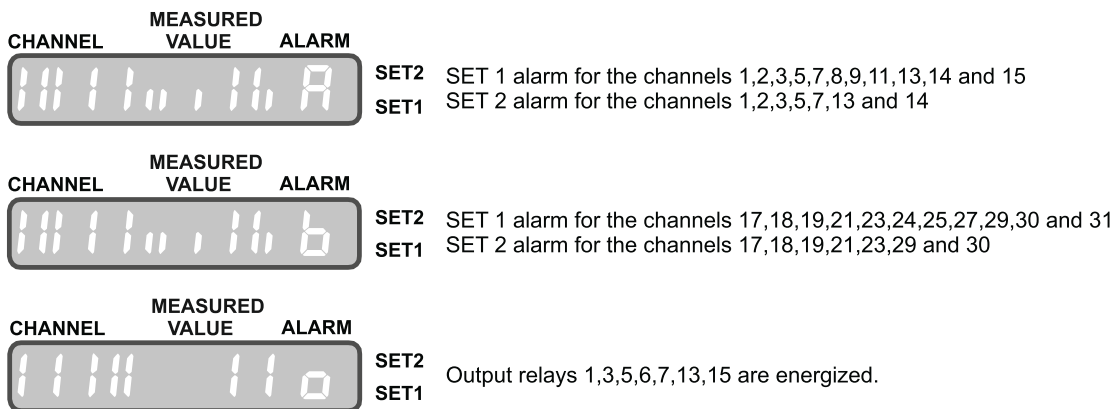
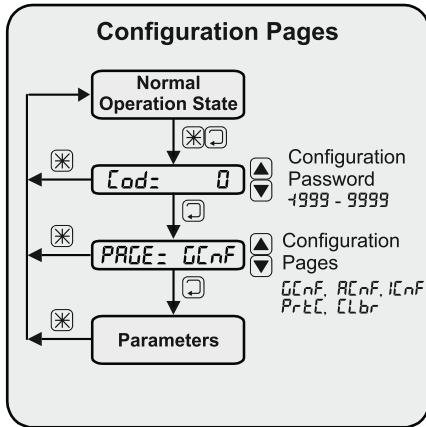

Figure 2.2. Alarm Pages

## 2.2 Configuration Pages



When the device is in the normal operation state, pressing the **Enter** and **Exit** buttons simultaneously enters the configuration mode. When the configuration mode is entered, "Cod" message is displayed for the security code. Security code is entered by using the **Down** and **Up** buttons. The factory setting of the security code is "10". If the correct code is entered, the user is authorized to change all the device settings including the calibration. Otherwise, the rights are only restricted to the settings of the "PrtC" page. After this process, PAGE = is written to first 5 digit of display and the name of the page is displayed in the last 4 digit. To pass between menus the **Down** and **Up** buttons are used. In order to return to the normal operation state, the **Exit** button should be pressed. In order to access to any configuration page, the **Enter** button is used and by pressing this button, the parameters in this page are displayed one by one. In this step, the parameter name is indicated in the first 4 digits of the display, and the parameter value is indicated in the last 4 digit of led display. In order to change the parameter values, the **Down** and **Up** buttons are used. To exit from any page the **Exit** button is used.

### 2.2.1 General Configuration Page

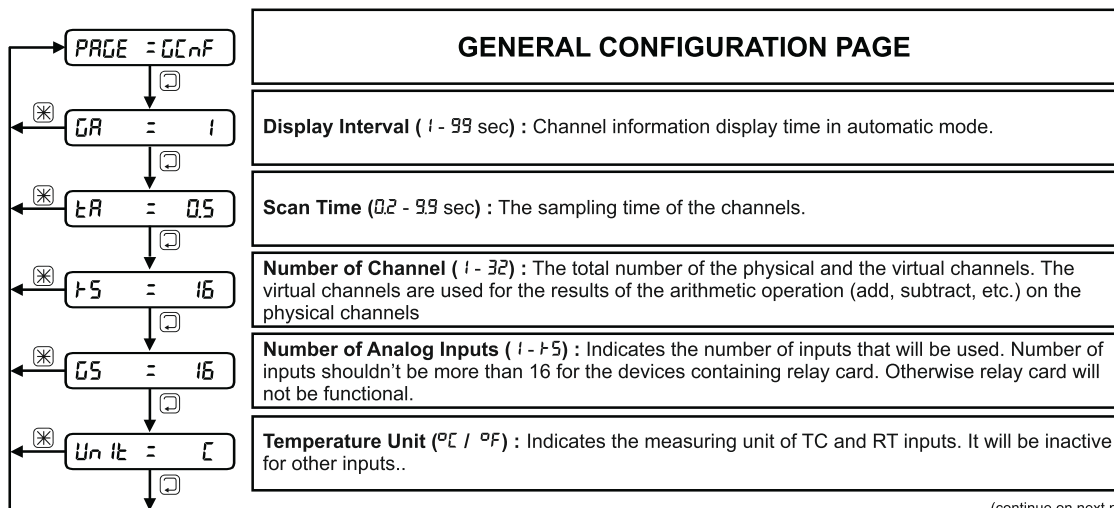

(continue on next page)



2.2.1 General Configuration Page

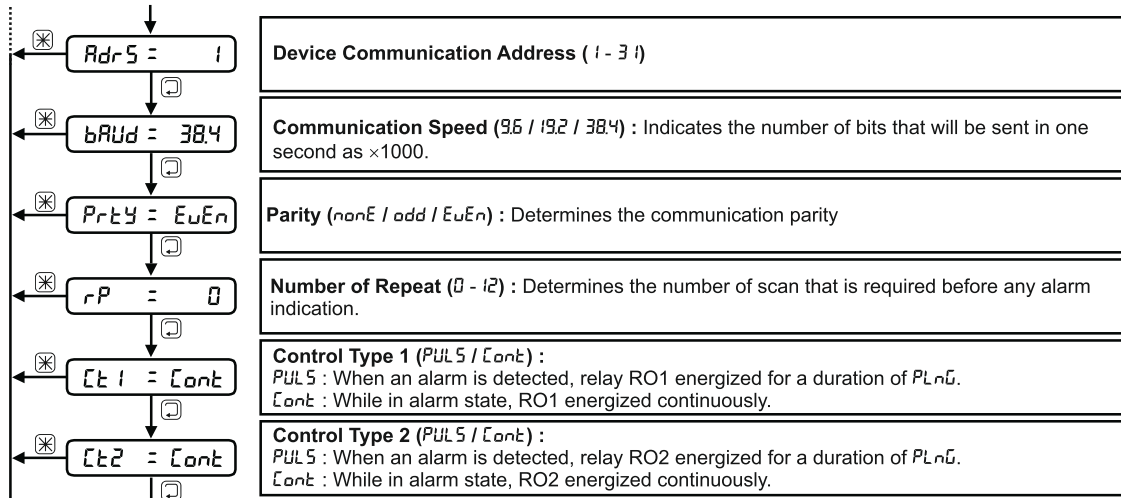

2.2.1 General Configuration Page

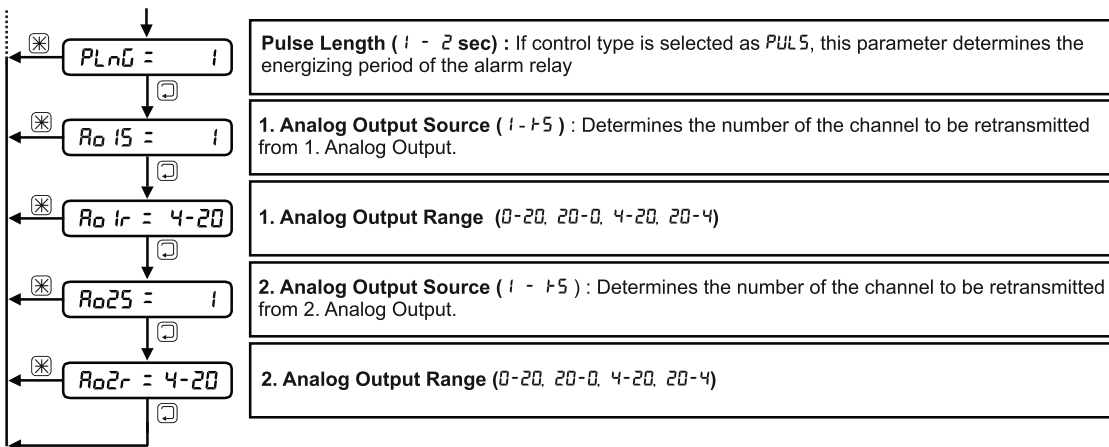

2.2.2 Alarm Configuration Page

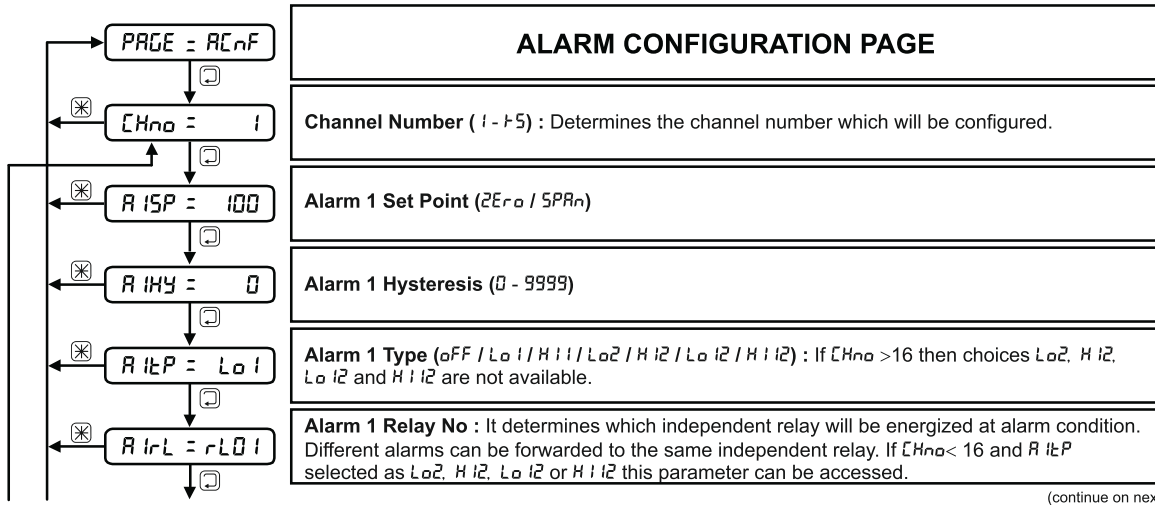

(continue on next page)

2.2.2 Alarm Configuration Page

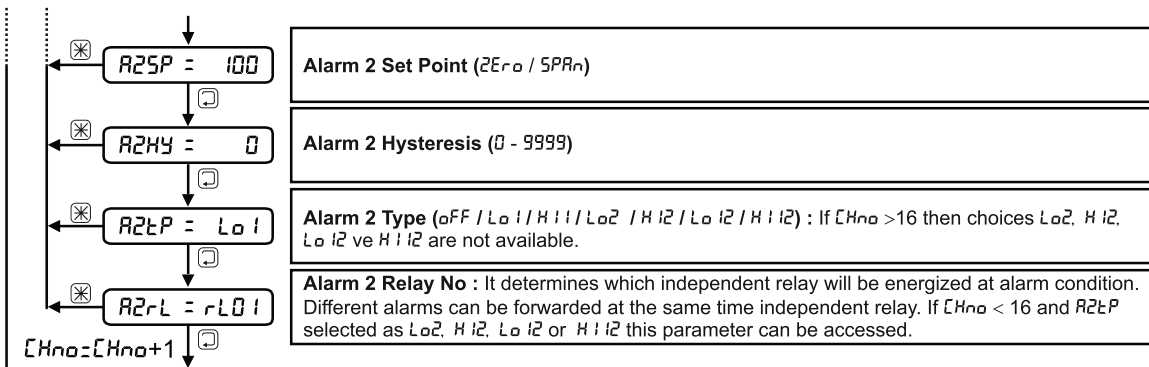

(continue on next page)

### 2.2.2 Alarm Configuration Page

The alarm types and the principle of generating alarms are given in the figure on the right. Alarm parameters are  $rP$ ,  $\text{Lk1}$ ,  $\text{Lk2}$ ,  $PLnG$ ,  $R1SP$ ,  $R1HY$ ,  $R1LP$ ,  $R1rL$ ,  $R2SP$ ,  $R2HY$ ,  $R2LP$  and  $R2rL$ . For each channel, set points  $R1SP$  and  $R2SP$  are defined. Those can be directed to common and independent alarm relays according to the values selected for  $R1LP$  and  $R2LP$ . When  $R1LP$  and  $R2LP$  is selected as *oFF*, the alarms will not be activated. When alarm type is chosen as  $L01$  or  $H11$  related alarm can only be directed to common alarm relays. Those relays are RO1 for Set 1 and RO2 for Set 2. When alarm type is selected as  $L02$  or  $H12$ , alarm can only be directed to independent relays determined by  $R1rL$  and  $R2rL$  parameters. Independent relays are R1, R2,...,R16. When alarm type is selected as  $L02$  or  $H12$ , related alarm is directed to the common and independent alarm relay described as above. Different alarms can be forwarded to the same independent relay. In this case related relay is used commonly by those alarms.  $rP$  is valid for all defined alarms, and defines the number of scans for alarm condition. As an example, if  $rP$  is selected as 3, alarm will be triggered, if the alarm condition persists at least three scan period.  $\text{Lk1}$  and  $\text{Lk2}$  are only valid for common alarms and at alarm conditions it defines whether the relay is energized continuously or during the defined pulse length.  $\text{Lk1}$  determines control type of RO1, and  $\text{Lk2}$  determines control type of RO2 relay.

**Note:** When any alarm condition occurs, the device switches to manual mode and indicates the channel information which causes the alarm state.

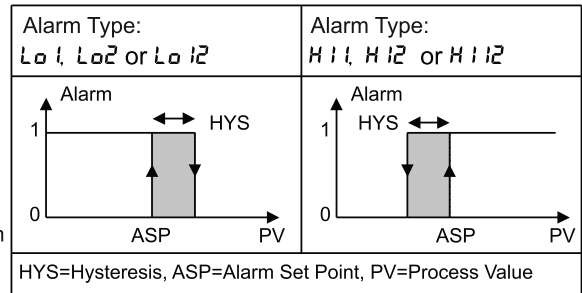

### 2.2.3 Input Configuration Page

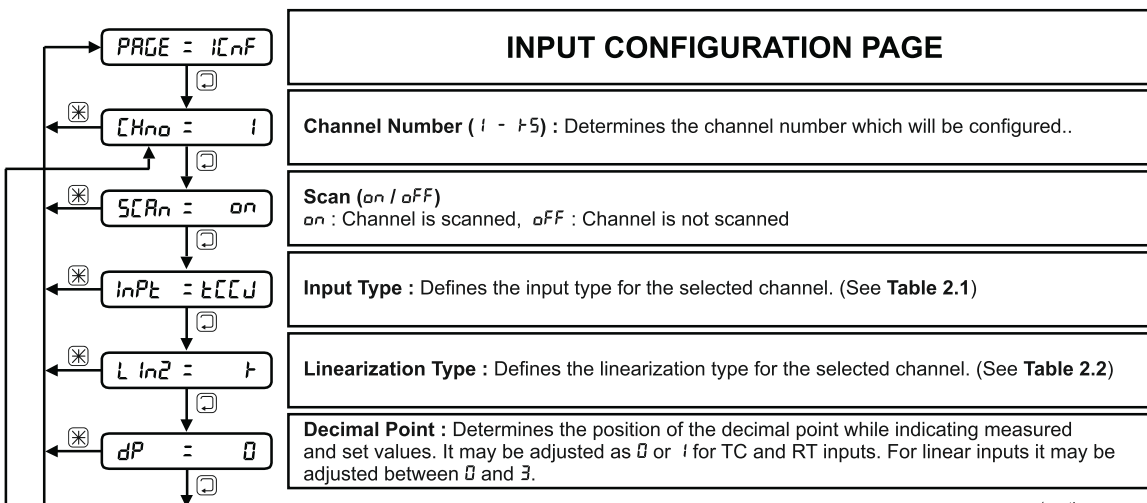

(continue on next page)

**2.2.3 Input Configuration Page**

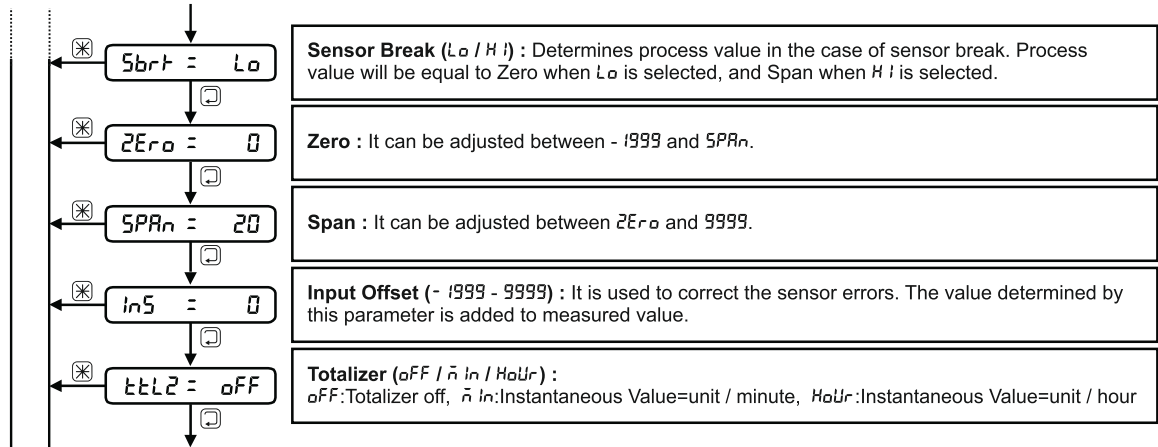

(continue on next page)

**2.2.3 Input Configuration Page**

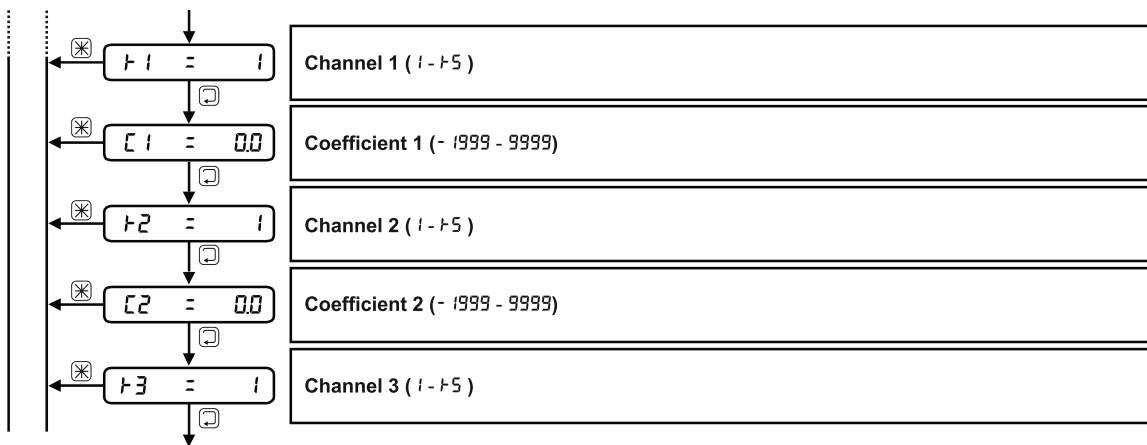

(continue on next page)

2.2.3 Input Configuration Page

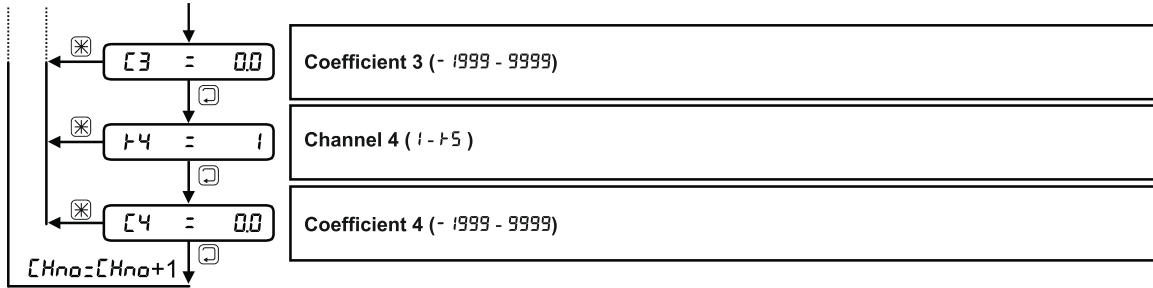

(continue on next page)

2.2.3 Input Configuration Page

The  $SCR_n$  parameter of unused channels should be adjusted as  $OFF$ . This reduces the overall channel scan time. If the input type is changed, jumpers on the input multiplexer card must also be organised accordingly. (See **Section 2.5 E-680 Jumper Settings**) Otherwise reading will be false. In case of any constant measuring error, this error can be removed by giving suitable value to  $IN5$  parameter.

**Example:** If the sensor produces  $3^\circ\text{C}$  more than normal value, error may be removed by adjusting  $IN5$  parameter to  $-3$ .

**Note:** When input type is selected as  $CU5E$ , it will be operate as  $PE$  if there is no custom inquiry.

Table 2.1.

| Input Types  |
|--|
| EEU (Thermocouple with cold junction compensation)   |
| EE (Thermocouple without cold junction compensation) |
| rE (Resistance Thermometer)                          |
| 0R20 (0-20 mA)                                       |
| 4R20 (4-20 mA)                                       |
| 0U50 (0-50 mV)                                       |
| 00U1 (0-1 V)   |
| 02U1 (0.2-1 V)                                       |
| 0U10 (0-10 V)  |
| RUU (Average)  |
| CU5E (Special)                                       |

(continue on next page)

2.2.3 Input Configuration Page

Table 2.2.

| Lineerization Type         | Standart    | Measuring Ranges |             |
|----------------------------|-------------|------------------|-------------|
|                            |             | (°C)             | (°F)        |
| L In (Linear)              | -           | -                | -           |
| SqrE (Squareroot)          | -           | -                | -           |
| FLnP (Flowrate-Squareroot) | -           | -                | -           |
| LnP (Flowrate)             | -           | -                | -           |
| b (Type B)                 | IEC 60584-1 | 60 , 1820        | 140 , 3308  |
| E (Type E)                 | IEC 60584-1 | -200 , 840       | -328 , 1544 |
| J (Type J)                 | IEC 60584-1 | -200 , 1120      | -328 , 1562 |
| K (Type K)                 | IEC 60584-1 | -200 , 1360      | -328 , 2480 |
| L (Type L)                 | DIN 43710   | -200 , 900       | -328 , 1652 |
| N (Type N)                 | IEC 60584-1 | -200 , 1300      | -328 , 2372 |
| R (Type R)                 | IEC 60584-1 | -40 , 1760       | 104 , 3200  |
| S (Type S)                 | IEC 60584-1 | -40 , 1760       | 104 , 3200  |
| T (Type T)                 | IEC 60584-1 | -200 , 400       | -328 , 752  |
| U (Type U)                 | DIN 43710   | -200 , 600       | -328 , 1112 |
| PE (Pt-100)                | IEC 60751   | -200 , 840       | -328 , 1544 |

When the linearization type selected as FLnP or LnP, related channel can be used for flow rate measurement. Flow rate measurement is calculated using differential pressure principle based on orifice plates with pressure and temperature compensation. In related channel input configuration, P1, L1, P2, L2 parameters determine the pressure channel, design pressure, temperature channel and design temperature respectively. When the InPE parameter is set to RuU, related channel will be a virtual channel and input value belonging to this channel is calculated as below.  
 Input Value = (PV<sub>K1</sub> × C1 + PV<sub>K2</sub> × C2 + PV<sub>K3</sub> × C3 + PV<sub>K4</sub> × C4) / 100.0  
 (PV<sub>X</sub> : Process Value of X. channel, CX : Coefficient of X. channel)  
 This input is linearized according to Ln2 parameter like other inputs to see the input value as process value Ln2 parameter must be set as Ln.  
 When the channel is on display, pressing ⊗ and ▼ together make the sum zero.  
 The channels of which the channel numbers are greater than input numbers are virtual channels. In these channels input type can only be chosen RuU. Otherwise no calculation can be done.

2.2.4 Security Configuration Page

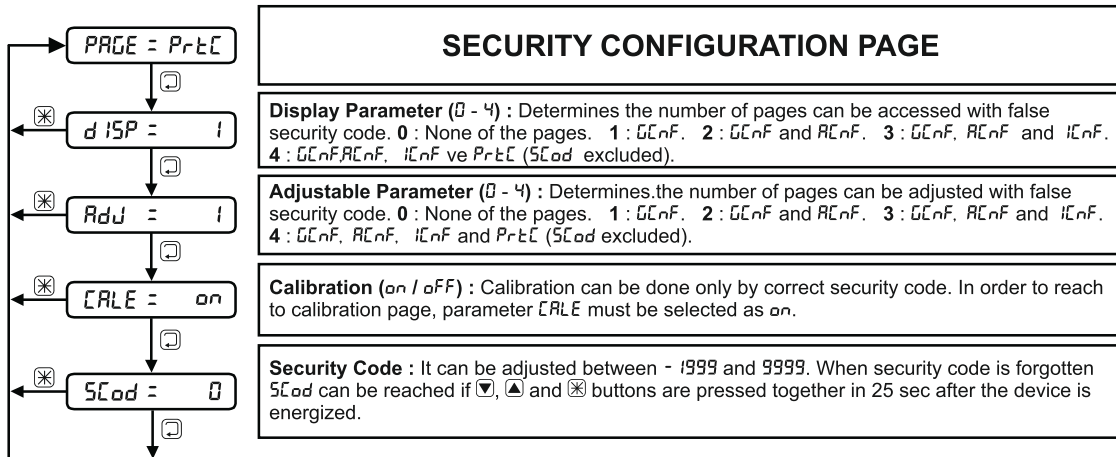

2.2.5 Calibration Page

○ The basic calibration of the controller is highly stable and set in the factory. Any erroneous operation in the *CRLb* page will corrupt the calibration parameter, and measurements will be faulty. The calibration parameters of the controller can be reinstalled in the *CRLb* page. If accurate calibration devices are not available, entering to the *CRLb* page is not advised.

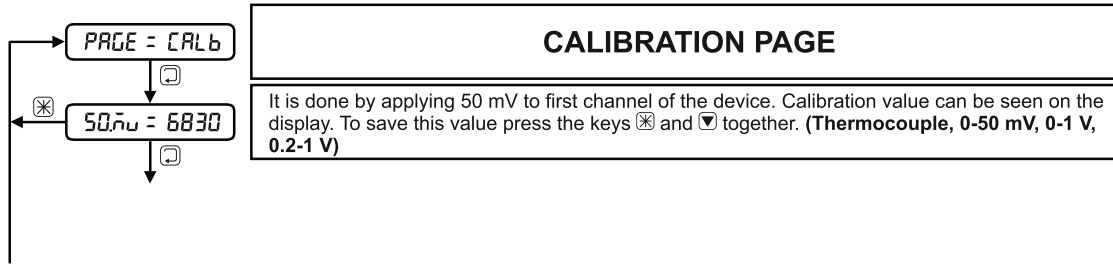

(continue on next page)

2.2.5 Calibration Page

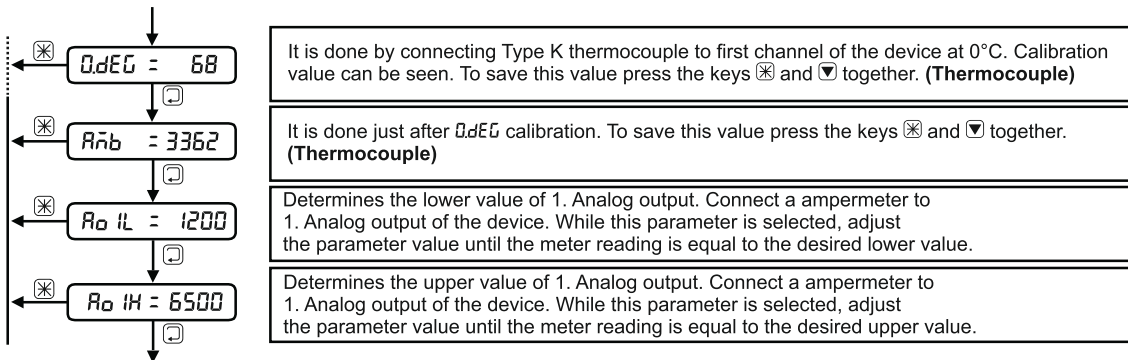

(continue on next page)

2.2.5 Calibration Page

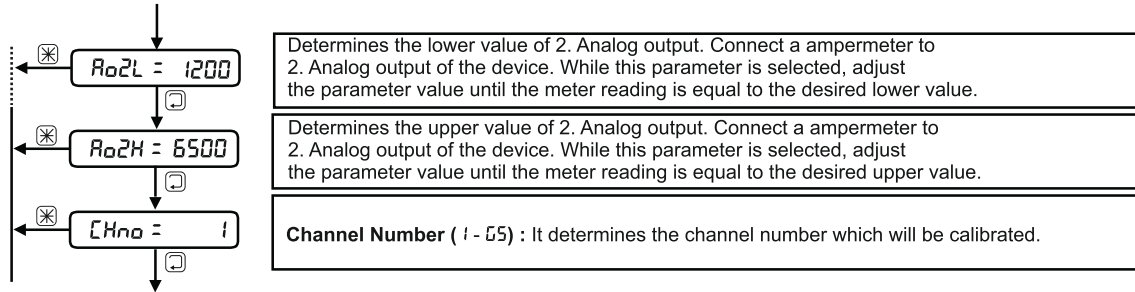

(continue on next page)

2.2.5 Calibration Page

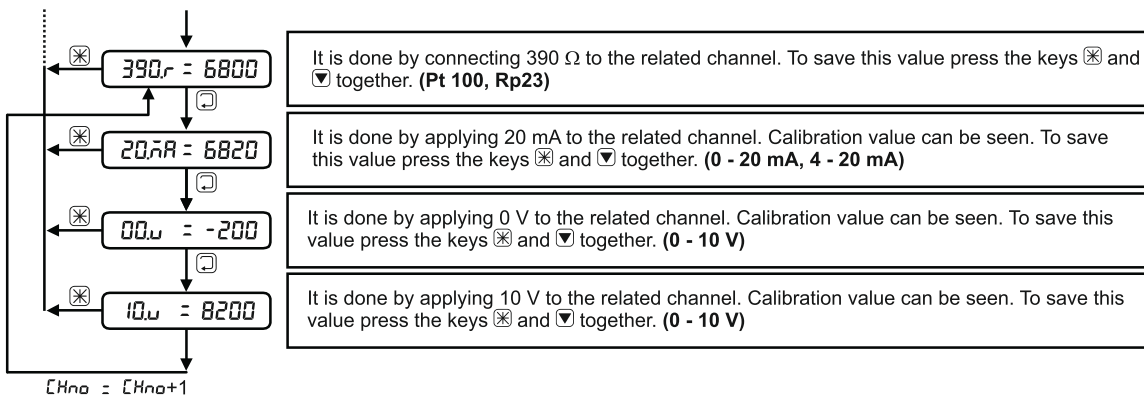



### 2.3. Warning Messages

During normal operation, channel numbers are displayed in first two digits of the display, the measured value in digits 4-7 and alarm information in digit 9. If there is any fault at the input information, measured value can not be seen. Instead of it, the messages at the following table are displayed.

| Message     | Description  | What To Do  |
|-------------|--|---|
| <i>oPEn</i> | Sensor break or not connected.                               | Check sensor and sensor connections.  |
| <i>UFL</i>  | Process value is below the sensor type measuring range.      | Check sensor and input sensor type.   |
| <i>oFL</i>  | Process value is over the sensor type measuring range.       |   |
| <i>nnnn</i> | Process value exceeds 9999 (without considering <i>dP</i> ). | Check the scale determined by the parameters <i>dP</i> , <i>ZErO</i> and <i>SPRn</i> . Check input value for linear inputs. |
| <i>uuuu</i> | Process value under -1999 (without considering <i>dP</i> ).  |   |

### 2.4. E-680 Connection Diagram

Back panel view of E-680 device is shown in **Figure 2.3.** There are 3 connection blocks X, Y and Z are located on the back panel. Connection group X is used for the processor and the power supply card. Connection group Y is used for multiplexer or relay card. Depending upon the configuration, this block may be used or not. Connection block Z is used only for multiplexer card. The connections of processor and the power supply card is given in **Figure 2.4.**, the connections of relay card that can be used in group Y is given in **Figure 2.5.** various connections of the multiplexer card that can be used in group Y and Z are given in **Figure 2.6.**, **Figure 2.7.**, **Figure 2.8.** and **Figure 2.9.** The number of terminals on the multiplexer and relay card depends on the type coding. (See **Section 1.1. Type Coding**)

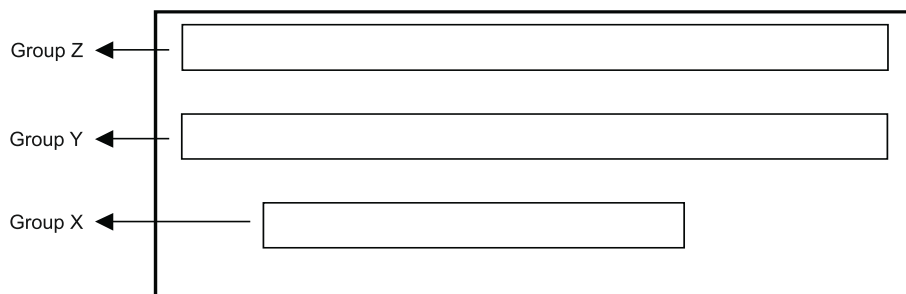

Figure 2.3. E- 680 Back Panel

(continue on next page)

2.4. E-680 Connection Diagram

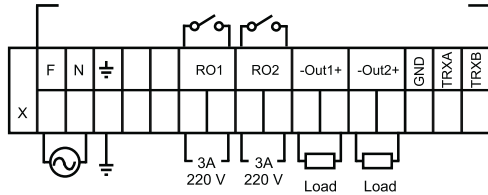

Figure 2.4. Processor Card Connection Diagram

For RS-485 communication line TRXA, TRXB and GND connections are used.

- The terminals F, N, RO1, RO2, OUT1 and OUT2 are electrically live. While the instrument is powered, never touch to these terminals.
- Before operating the controller, ensure that the controller is correctly configured. Incorrect configuration could result malfunction

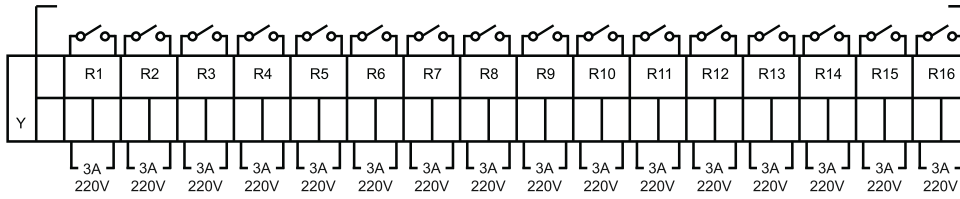

Figure 2.5. Relay Card Connection Diagram

(continue on next page)

2.4. E-680 Connection Diagram

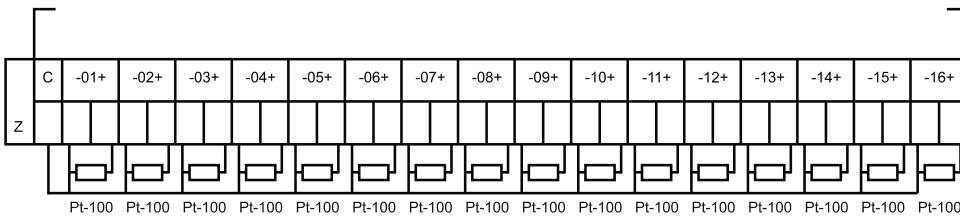

Figure 2.6. Pt-100 Connection Diagram

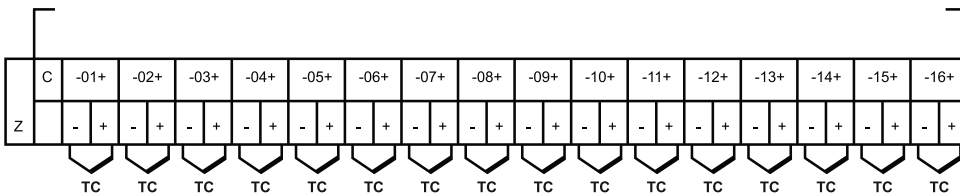

Figure 2.7. Thermocouple Connection Diagram

(continue on next page)

## 2.4. E-680 Connection Diagram

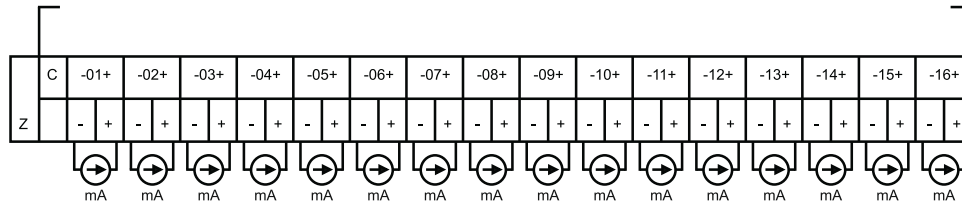

Figure 2.8. mA Source Connection Diagram

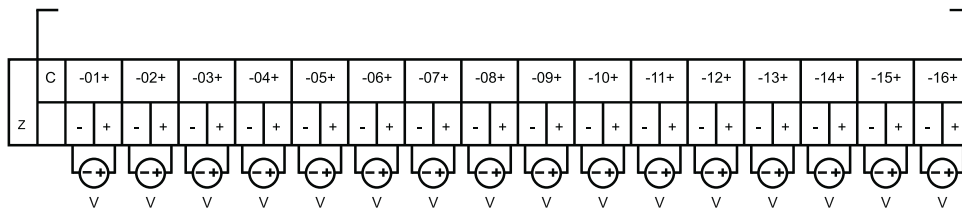

Figure 2.9. Voltage Source Connection Diagram

## 2.5. E-680 Jumper Settings

The jumper settings are different for TC (mV / V), RT, mA and 10 V inputs. The input signal applied to any channel must be compatible with  $I_{nPE}$  parameter of  $iCnF$  Input Configuration Page and jumpers on the input multiplexer card.

Device has 1 or 2 multiplexer card according to the number of channels. Devices, having channel number up to 16 have a single, devices having more than 16 channels have 2 multiplexer cards.

The jumpers are located on the multiplexer cards. **Figure 2.10.** shows top view of multiplexer card. In order to access to multiplexer cards, dismantle two screws at the back side and remove the cover.

Upper connection group Z is the first multiplexer card. It includes the channels 1-16.

If device has more than 16 channels, channel 17 to 32 are on the multiplexer card located at the middle slot.

In order to reach this card, unscrew the upper two screws and slack the lower two screws and turn the fixing plate.

Then remove the cable of first multiplexer card and dismantle it by pulling from rails.

After completing necessary arrangements, first multiplexer card is attached by the same way to its place. Screw the plate to fix the cards again. Finally place the cover.

Multiplexer card address jumpers must not be changed.

### 2.5. E-680 Jumper Settings

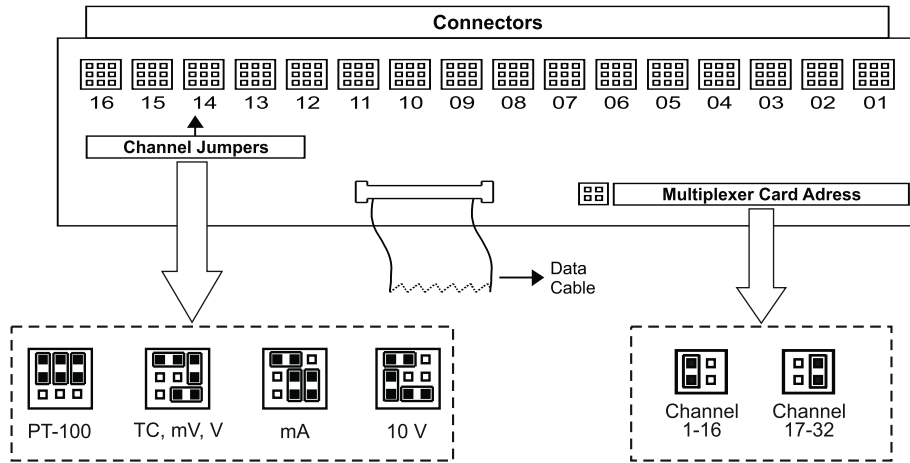

Figure 2.10.

### 2.6. E-680 Communication Connection

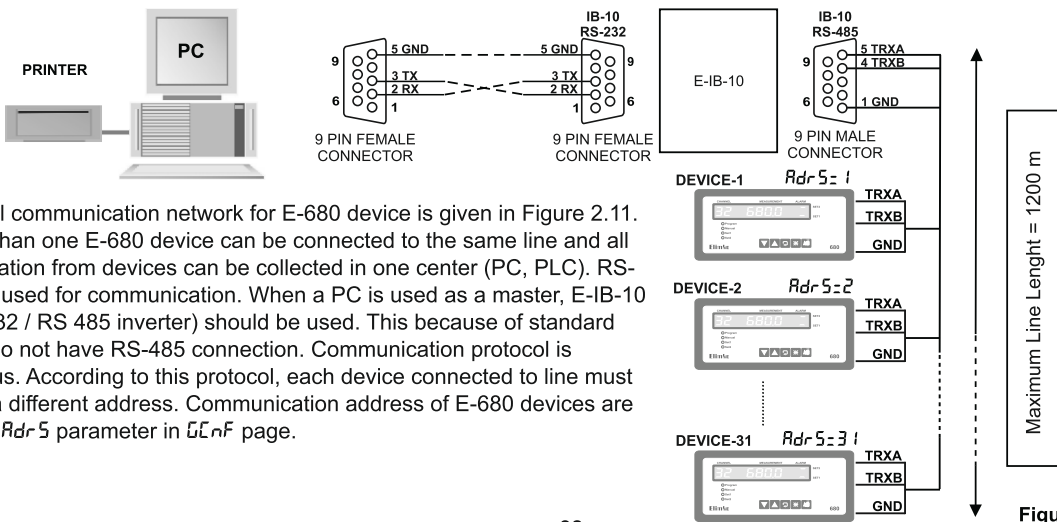

Figure 2.11.

Typical communication network for E-680 device is given in Figure 2.11. More than one E-680 device can be connected to the same line and all information from devices can be collected in one center (PC, PLC). RS-485 is used for communication. When a PC is used as a master, E-IB-10 (RS-232 / RS 485 inverter) should be used. This because of standard PC's do not have RS-485 connection. Communication protocol is Modbus. According to this protocol, each device connected to line must have a different address. Communication address of E-680 devices are set by *Adr 5* parameter in *UUNF* page.